

LEADER TEST INSTRUMENTS

MODEL LBO-502

OSCILLOSCOPE / VECTORSCOPE

OPERATING INSTRUCTIONS
AND SERVICE MANUAL

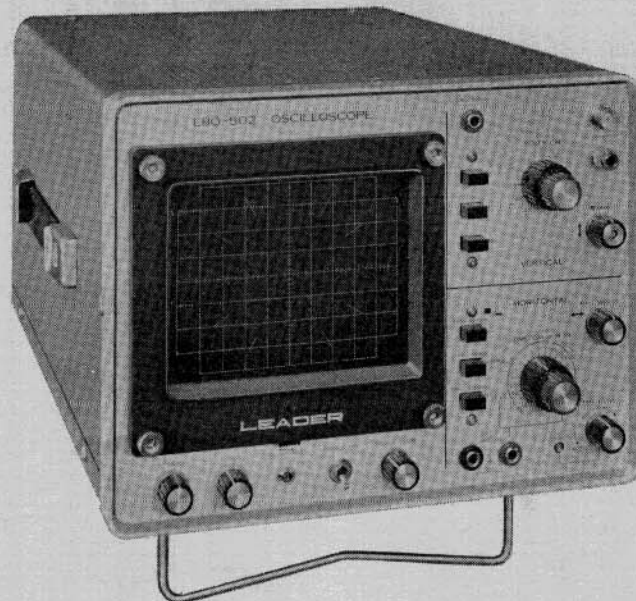

LEADER ELECTRONICS CORP.

TABLE OF CONTENTS

	PAGE
1. INTRODUCTION	1
2. SPECIFICATIONS	1
3. PRECAUTIONS	1
3.1 Power Source Voltage	1
3.2 Signal Input	3
3.3 Intensity	3
3.4 Tilt of Horizontal Traces	3
3.5 Operation in a Powerful Magnetic Field	3
4. DESCRIPTION OF PANEL FUNCTIONS	3
4.1 Front Panel	3
4.2 Rear Panel	10
5. OPERATING INSTRUCTIONS	11
5.1 Preparation For Use	11
5.2 AUTO. Synchronization	11
5.3 LEVEL Synchronization	12
5.4 Synchronization by EXT. TRIG. SOURCE	13
5.5 Synchronization to TV Waveforms	13
5.6 Voltage Measurement	14
5.7 Pulse Measurements	17
5.8 Frequency Measurement	20
5.9 TV-V and TV-H Range	21
5.10 EXT. H. IN	21
5.11 VECTORSCOPE Application	22
5.12 Checking Modulation in AM Transmitters	25
5.13 Time Measurement and Frequency Marking	27
6. CIRCUIT DESCRIPTIONS	27
6.1 Vertical Input	27
6.2 Amplifiers	28
6.3 Time Base	28
6.4 CRT Section	29
7. MAINTENANCE	29
7.1 General	29
7.2 Exposing the Chassis	30
7.3 Location of Adjusters and Test Points	30
7.4 CRT Circuit	31
7.5 CAL 0.5V _{p-p} Output	31
7.6 Vertical Amplifier Circuit	31
7.7 Time Base Circuit	33
8. PIN CONNECTIONS, TRANSISTORS AND CRT	37
9. TRANSISTOR CHECKING	39
10. VOLTAGE AND WAVEFORM CHART	40
11. NAME AND NUMBER OF PCB's	40
12. PARTS LIST	41
13. BLOCK DIAGRAM	52
14. SCHEMATIC DIAGRAMS	53
15. PCB ASSEMBLY DRAWINGS	61

1. INTRODUCTION

The LBO-502 is an all solid state wideband oscilloscope/vectorscope. It is extremely compact, lightweight and offers a new ease of operational convenience.

It has broad applications in every conceivable branch of electronics and has no equal in the servicing and troubleshooting of home entertainment products. Its use is very highly recommended in laboratories, schools, and production facilities.

2. SPECIFICATIONS

Vertical Amplifier

Sensitivity	10MVp-p/cm to 20Vp-p/cm $\pm 3\%$, calibrated in 11 steps, 1-2-5 sequence and continuous adjuster (uncalibrated)
Bandwidth	DC to 15MHz, -3dB (with 3cm deflection)
Rise Time	23 nanoseconds
Input Impedance	1Meg Ω shunted by 40pfd (with 10:1 probe, 10Meg Ω shunted by 15pfd or less)
Input Connector	BNC
Calibration Voltage	0.5Vp-p $\pm 3\%$, 1kHz; square wave

Horizontal Amplifier

Sensitivity	200MVp-p/cm
Bandwidth	2Hz - 200kHz, -3dB
Input Impedance	1Meg Ω , shunted by 40pfd

Time Base

Sweep Speeds	1 $\mu\text{s}/\text{cm}$ to 0.2s/cm, calibrated in 17 steps, 1-2-5 sequence and uncalibrated continuous adjuster; TV-V (33.3ms/10cm; 30Hz) and (127 $\mu\text{s}/10\text{cm}$; 15.750/2kHz) preset positions.
--------------	---

Magnification	$\times 5$ (max. speed 200 nanosecs/cm)
---------------	---

Synchronization	Triggered and automatic, internal or external at + or - slope.
-----------------	--

Intensity Modulation	External input over 15Vp-p, negative polarity.
----------------------	--

Power Supply	115/230V; 50/60Hz; 40VA $\pm 5\text{VA}$
--------------	--

Size and Weight	73/8" h \times 91/8" w \times 15" d, 17lbs. approx.
-----------------	---

Accessories	Direct/Low capacitance probe LP-8X 1
	Terminal adaptor 1
	Test leads (three per set) 1
	Operating instruction 1

3. PRECAUTIONS

3-1 Power Source Voltage

The AC power input is normally wired for 105 ~ 125V, 50/60Hz operation. For other voltages, changes are necessary in the transformer primary connections. Refer to Fig. 3-1 for connections to match the average line voltage, 100, 115, 200, 215 or 230V.

Terminal Arrangement and Wiring Diagram of Primary Windings

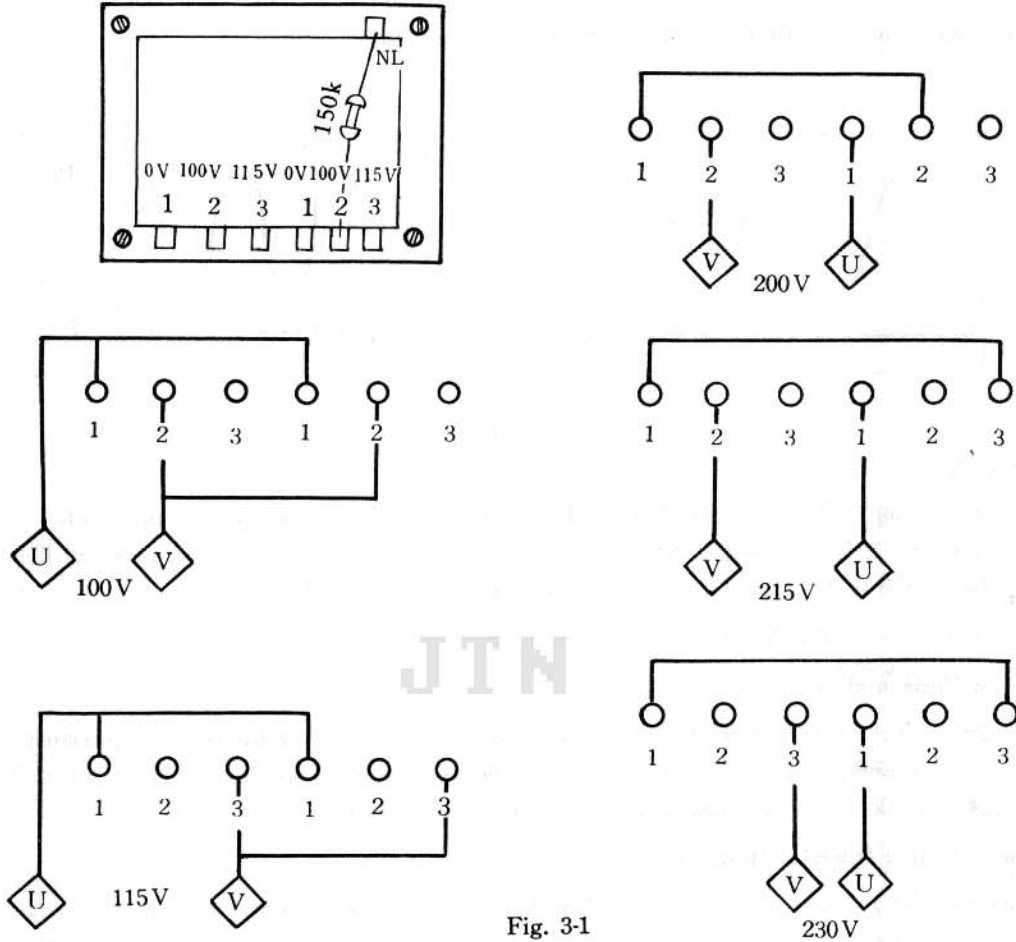

Fig. 3-1

The AC line fuse ratings are shown below.

Average Line Voltage	Fuse Rating
100V 115V	1A, slow blow
200V 215V 230V	0.5A, slow blow

3-2 Signal Input

A voltage higher than 600V (P-P+D.C.) applied to the Vert. Input, Ext. H, Trig. Input or the low capacitance probe may damage circuit components.

The value of 600V (P-P+D.C.) is shown in the following figures:

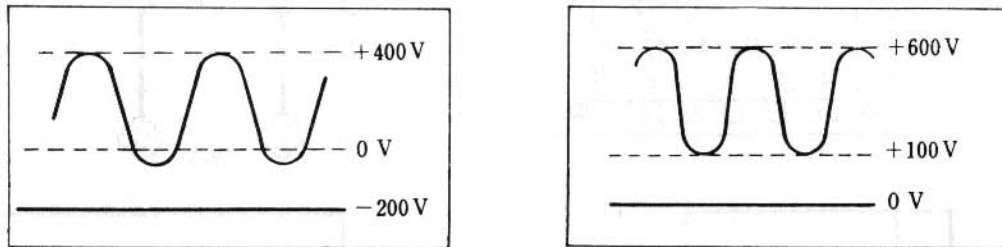

Fig. 3-2

3-3 Intensity

An accelerating voltage of 1800V is applied to the cathode ray tube during operation. If the cathode ray tube is left with a bright dot, (no sweep), or with unnecessarily raised intensity, the fluorescent screen may be stained with ion spots in the form of white lines or black blots.

The Intensity should be maintained at a minimum level.

3-4 Tilt of Horizontal Traces

The effect of the earth's magnetic field may cause slight tilting of the traces due to placement of the instrument. If the tilt is operationally inconvenient, change the placement of the unit or slope the scale by means of the SCALE TILT knob on the hood so that the scale is parallel with the traces.

3-5 Operation in a Powerful Magnetic Field

Operation in a powerful magnetic field will cause distortion of waveforms or make traces tilt excessively. If the instrument is operated close to machinery or equipment that use a large transformers(200 or 300VA rating), a great deal of hum will be noted. In the worst case, the traces may be so severely tilted that self-restoration is not possible. In this case, demagnetize the instrument with a degaussing coil such as used in a color television set.

4. DESCRIPTION OF PANEL FUNCTIONS

The operational functions on the front and rear panels are described below. The numbers refer to their placement as shown on the following panel drawings.

4-1 Front Panel

(1) CRT Hood (Bezel)

Removal of the four hood nuts, will free the hood, scale plate, spacer and green filter. (Hold the SCALE TILT knob during the above procedure to avoid loss of scale assembly.)

(2) The large boxes on the scale plate are calibrated in centimeters; the small markings on the center vertical and center horizontal scale lines are spaced at 2 millimeters.

Front Panel

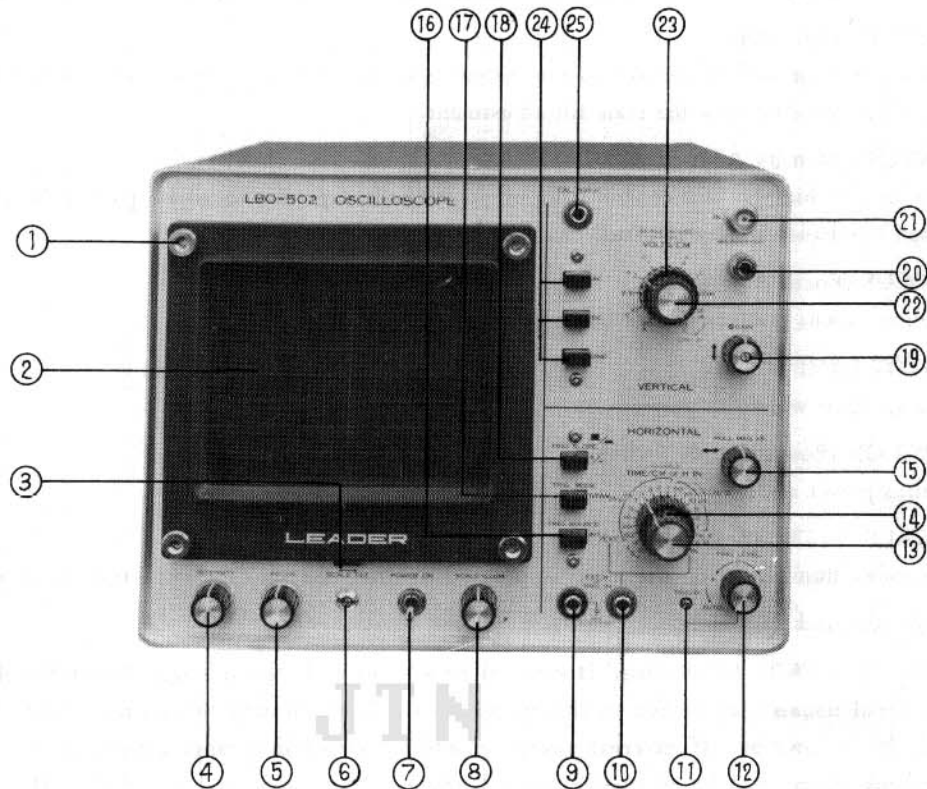

Fig. 4-1

Rear panel

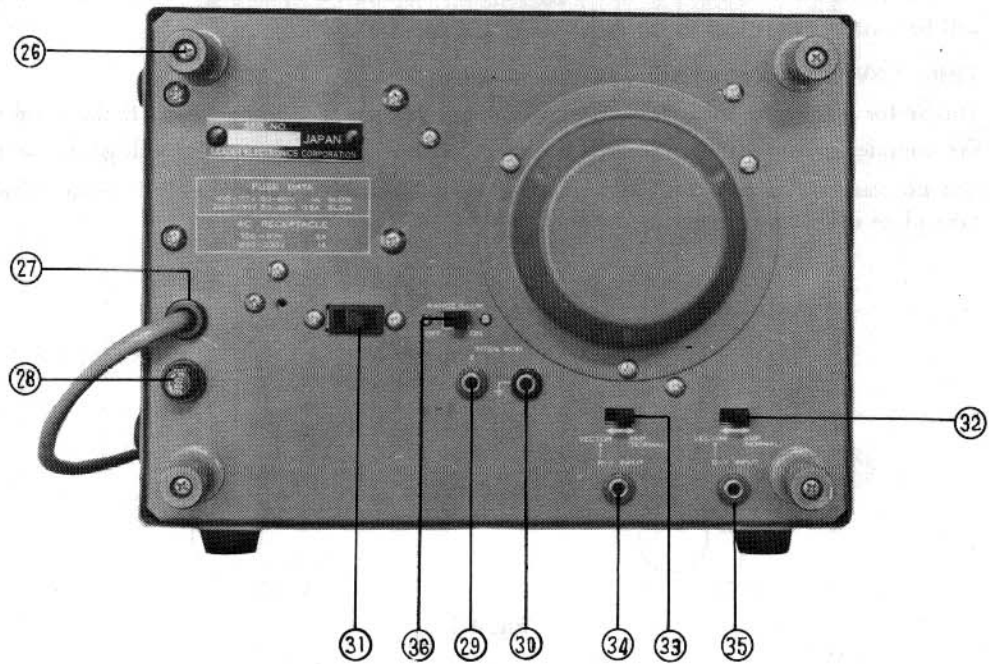

Fig. 4-2

In addition, the oblique lines, every 30 degrees, pointing towards the center of the scale are for vectorscope or vector pattern use. (This application is covered in detail on page 22 of this manual.)

- (3) **SCALE TILT** \longleftrightarrow
Slight Horizontal line tilt due to the influence of the earth's magnetic field or any other magnetic field may be corrected with the scale tilt adjustment.
- (4) **INTEN** (Intensity Adjustment)
Varies the bias on the control grid of the cathode ray tube to adjust pattern luminance or brightness. High luminance will cause return trace lines to appear on the screen.
- (5) **FOCUS** (Focus Adjustment)
Adjusts focus grid voltage for best clarity of display.
- (6) **PILOT LAMP**
Lamp lights when the power is on.
- (7) **PWR ON** (Power Supply Switch)
Turns power on or off.
- (8) **SCALE ILLUM.** (Scale Illumination)
Provides illumination on the scales at proper brightness for easy scale and trace readings.
- (9) \equiv (Ground Terminal)
- (10) **EXT. H or TRIG. IN** (External Horizontal Axis Input or External Trigger Input Terminal)
External signals may be fed to the horizontal amplifier through this terminal when switch (14) is set in the H IN position. If external sweep or internal sweep in a range other than the H IN are used, and external trigger synchronization is desired, the synchronizing signal is added to this terminal with switch (16) at Ext. position.
- (11) **TRIG.'D LAMP** (Synchronization Indicating Lamp)
This lamp indicates whether or not trigger synchronization is operating. When it does not light, waveforms will be unstable (not locked in) or no trace will appear.
- (12) **TRIG. LEVEL** (Synchronization Level Adjustment)
This is for stabilizing the starting point of trigger sweep at a proper level. If the fixed value is taken off the complex portion of the waveform under observation, trig. lamp (11) will go out and sweep will stop, and no trace will appear on the screen due to unblanking action of the CRT circuit. The same action will take place when there is no input signal.

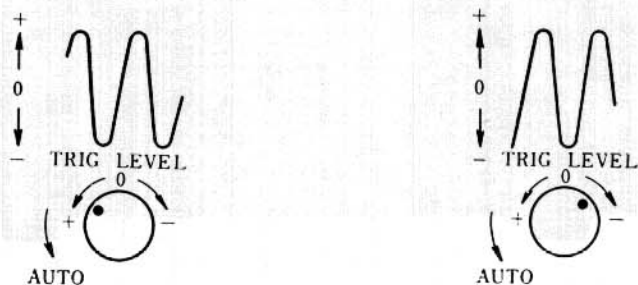

Fig. 4-3

Automatic synchronization is accomplished by turning this knob fully counter-clockwise until it clicks. In this case, horizontal bright lines (Traces) will appear even when there is no input signal, automatic synchronization will be performed around the approximate center of its waveform and the lamp (11) will light.

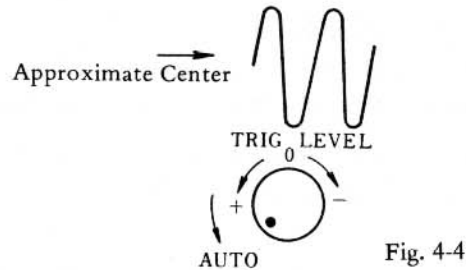

Fig. 4-4

- (13) VARIABLE (Fine Adjustment of Sweep Time or Horizontal Sensitivity, Red Knob)

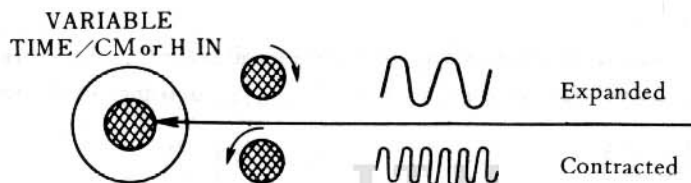

Fig. 4-5

It will not work when the switch (14) is in TV-V or TV-H range.. In H IN range and when a signal is fed to the horizontal axis by way of EXT. or TRIG. IN. terminal of (10), it will operate as a fine adjuster of horizontal sensitivity.

- (14) TIME/CM. or H IN (Switching of Sweep Time and External Horizontal Axis, Black Knob)
Seventeen steps from $1\mu\text{s}/\text{CM}$ to $0.2\text{s}/\text{CM}$. When measurement is made by the use of the indicated time, set the VARIABLE (13) (red knob) to CAL'D by turning it fully clockwise.

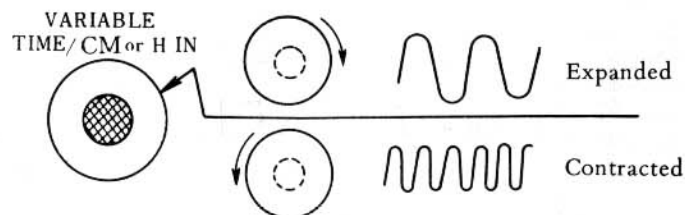

Fig. 4-6

The TV-V and TV-H ranges are preset to observe two cycles each of the vertical and horizontal periods of television on 10CM. In this case, of course, the VARIABLE control (13) does not work. With this knob (14) in the H IN range, the time axis circuit stops working, and a signal can be fed to the horizontal amplifier directly from an external source.

(15) **↔** Knob

Clockwise rotation will shift the pattern to the right and vice versa.

PULL MAG X5

Switch for increasing gain of the horizontal amplifier. When pulled, the speed of TIME/CM, (14) will be multiplied five times; the sweep time will be 1/5 of the indicated value.

(16) **TRIG. SOURCE** (Synchronizing Signal Source Switch)



Selects synchronizing signal source. At INT., part of the signal taken from the vertical input is utilized for synchronization. Normal operation is performed with this switch at the INT. position.

EXT. position is used when synchronization is desired from another signal in close relation to the period of the signal fed to the vertical input. This synchronization signal is fed to terminal (10).

(17) **TRIG. MODE**

In normal operation, this switch must be set to NORM. position. It must be set to TV position when the switch (14) is in TV-V or TV-H range, or when synchronization with the TV composite video signal is desired.

(18) **TRIG. SLOPE** (Synchronization Slope Switch)

If triggered sweep is desired against the positive slope of waveforms displayed on the screen, set this switch to (+)  position, and against negative slope, set it to (-)  position, whichever is applicable.

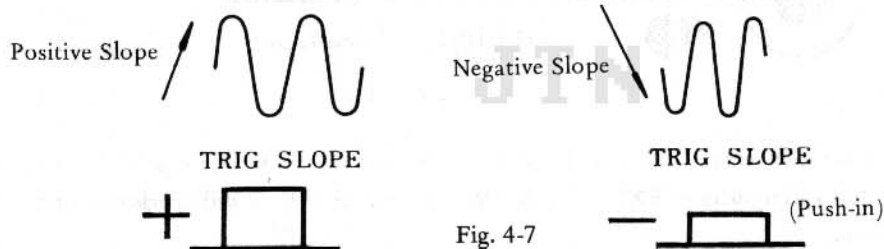
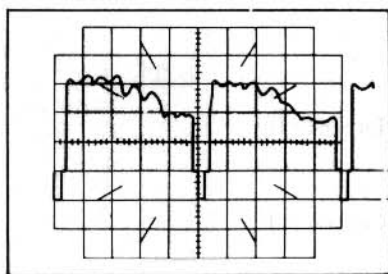

Fig. 4-7

For observation of composite TV video signals it is necessary to follow procedure (17) and at the same time select the same slope polarity as the synchronizing signal of the video signals.



NOTE: TRIG. SLOPE

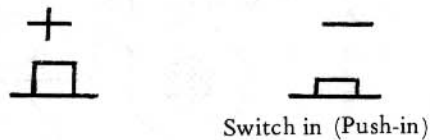

Fig. 4-8

For positive polarity, set the TRIG. SLOPE to (+) position.

(19) **↑** (Vertical Positioning Adjustment)

Clockwise rotation will move pattern up, and vice versa.

⊗ GAIN (Sensitivity Adjuster)

After **Ⓣ** turned fully clockwise and clicked adjustment can be made to bring sensitivity of Vertical Amplifier to indicated value.

- (20) (Ground Terminal)
- (21) IN (Vertical Axis Input Terminal)
- (22) VARIABLE (Vertical Sensitivity Fine Adjustment Red Knob)

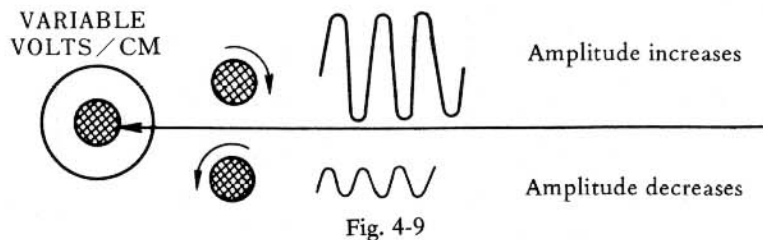

- (23) VOLTS/CM (Vertical Sensitivity Switch, Black Knob)
- Eleven steps from 0.01V/CM to 20V/CM. If measurement is made with use of the indicated voltage sensitivity, set the VARIABLE (22) (red knob) to CAL'D by turning it fully clockwise until clicked. Note that the indicated voltage sensitivity is only applicable to the signal directly fed to Input Terminal (21). If a 10 to 1 low capacitance probe (such as LPB-15X and LP-8X made by LEADER) is connected to the Input Terminal (21), the values are ten times the indicated voltage.

SCALE IN Use

It will be noted that markings, A, B, and C, on the switch at different ranges correspond with the scale graduations on the graticule, see Fig. 4-10 and Fig. 4-11. When the VARIABLE (red) knob is at CAL'D, the scale in use will be illuminated. If the illumination is not required, set the RANGE ILLUM. switch, (36) on rear panel, at OFF.

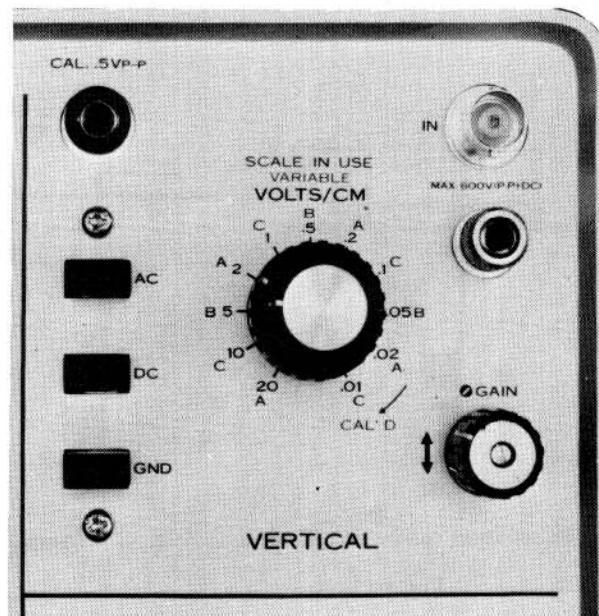

Fig. 4-10

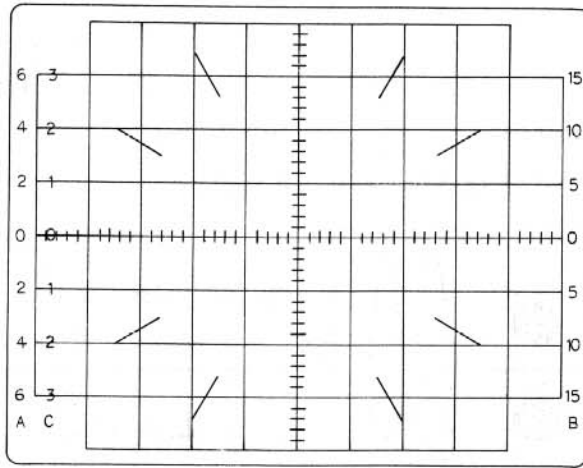

Fig. 4-11

(24) AC-DC-GND. (Alternating Current-Direct Current-Ground Switch)

Switches the coupling of the signal to Vertical Axis Input (21). DC coupling is obtained at the DC position, at AC position the direct current component is removed by a capacitor. The GND position grounds the amplifier input and opens Input Terminal (21).

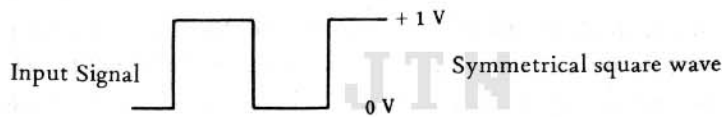

Fig. 4-12

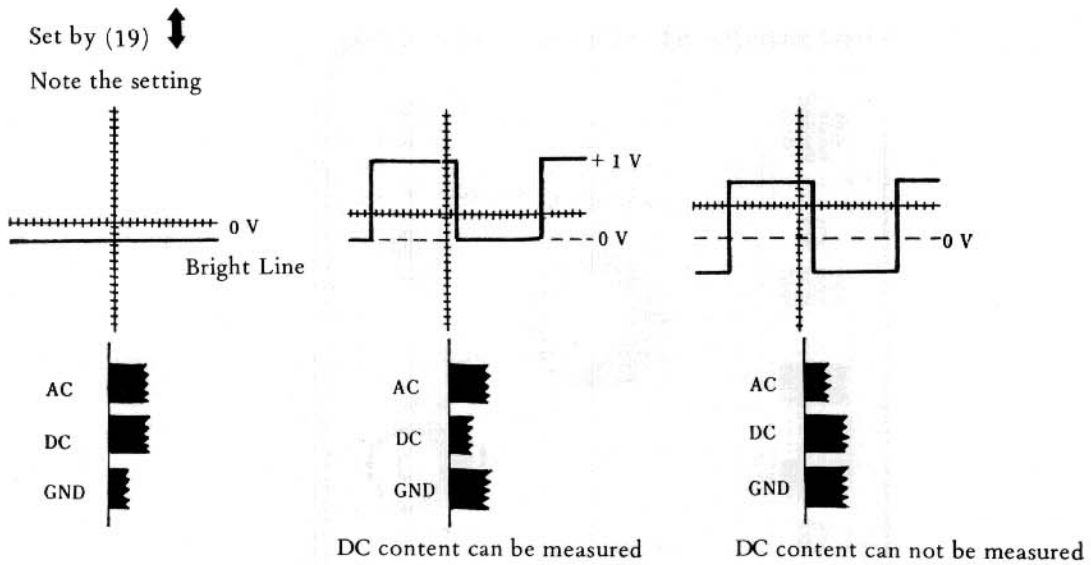

Fig. 4-13

(25) CAL 0.5Vp-p (Calibration Wave)

Standard signal output terminal for amplitude and waveform calibration. The frequency is a square wave signal, 0.5Vp-p, at 1kHz.

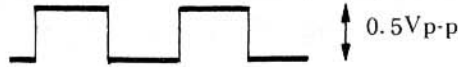

Fig. 4-14

4-2 Rear Panel

- (26) Legs used for Vertical Viewing and/or A.C. line cord winding convenience. Wind the AC cord around legs.

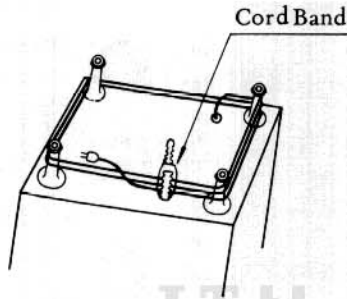

Fig. 4-15

(27) AC Cord

Observe caution relative to the rated line voltage. (Refer to Section 3-1).

(28) FUSE

Fuse is released with the cap when rotated counter-clockwise. Note the type and rating of the fuse to be used. (Refer to Section 3-1).

(29) INTEN. MOD. Z (Intensity Modulation Terminal)

(30) Ground Terminal

(31) AC RECEPTACLE

Outlet for direct power connection to auxiliary equipment, independent of power switch and line fuse; indicated current rating is not to be exceeded.

(32) } VECTOR AMP (NORMAL) switches

(33) }

To be set at VECTOR when the instrument is used as a vectorscope. Normally set at NORMAL position.

(34) } R-Y INPUT and B-Y INPUT terminals

(35) }

For connections to R-Y and B-Y signals in a color TV set when the instrument is used as a vectorscope. The R-Y INPUT is used when checking modulation in an AM transmitter.

(36) RANGE ILLUM.

Switch for turning on the lamps used in illuminating the relevant scales for the VOLTS/CM ranges, see (23).

5. OPERATING INSTRUCTIONS

The LBO-502 differs from conventional oscilloscopes in that a trigger signal obtained from the input signal triggers and controls the sweep signal generator circuit (Trigger Sweep). When a signal is fed to the input, trigger pulses synchronizing with the input signal are generated. These pulses start the sweep circuit and display bright lines or traces on the screen. If traces are desired to constantly show on the screen as with a conventional oscilloscope, set the TRIG LEVEL (12) at the AUTO position by turning it counter clockwise until clicked.

5-1 Preparation For Use

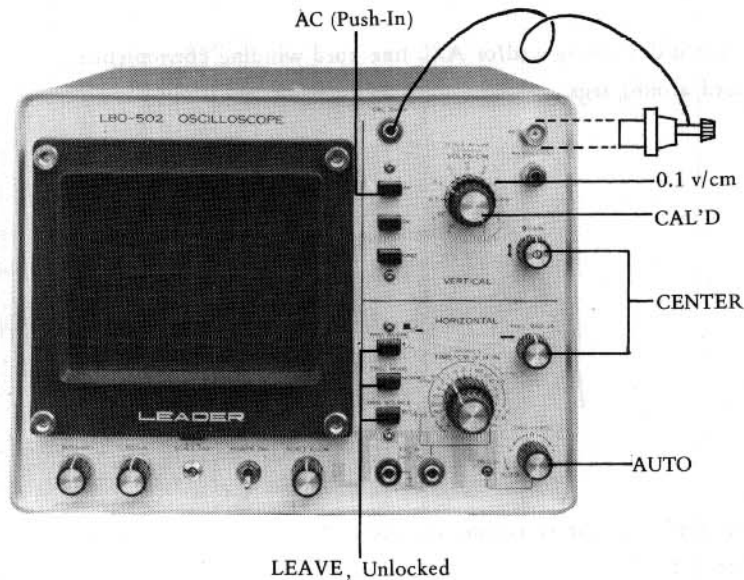

Fig. 5-1

Do not turn on power until all other settings shown on Fig. 1 have been made.

- Notes:
1. Set the VERTICAL VARIABLE (red knob) (22) on the CAL'D position by turning it clockwise until a click is heard.
 2. Set the TRIG. LEVEL (12) on the AUTO position by turning it counterclockwise until a click is heard.

After all settings are made, connect line cord to A.C. outlet. Turn the power switch to the POWER ON position. A display will appear on the screen in approximately ten seconds. The CAL. 0.5Vp-p is applied to the 0.1V/CM range, a square wave form with an amplitude of 5 CM shows on the screen. Since AUTO SYNC. setting is used a stable (locked) waveform is displayed. Position the waveform for best viewing by adjusting the INTEN., (4) FOCUS., (5) and/or (19) \updownarrow , (15) \leftrightarrow controls.

5-2 Auto Synchronization

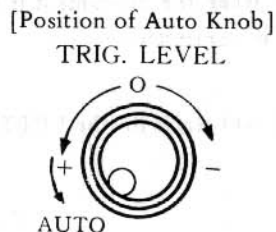

Fig. 5-2

AUTO Synchronization is used for synchronization of comparatively simple waveforms. With AUTO Synchronization, the sweep circuit is on even when no input signals are applied. Once an input signal is present the TRIG'D lamp (11) is lit and a synchronizing signal is developed from the input signal to lock in the input signal waveform. Thus, a trace will always be present in the AUTO synchronization position as in conventional oscilloscopes. (Example of AUTO Operation)

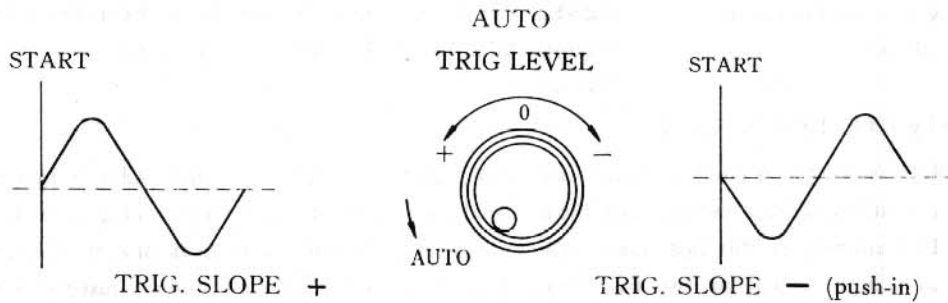

Fig. 5-3

During AUTO operation, sweeping always starts near the center of a waveform. Even if the amplitude of the input signal varies, synchronization is maintained as long as the amplitude does not fall below a minimum synchronization amplitude of 1 CM. When the waveform is difficult to stabilize (lock), increase the vertical amplitude or use the TRIG SLOPE switch, (18) choose the proper polarity for lock in of waveform. If complexity of the waveform still prevents synchronization, adjust the TRIG. LEVEL knob as explained in the next paragraph 5-3.

5-3 LEVEL Synchronization

It possible to start sweeping at any desired point of a waveform by adjusting the TRIG. LEVEL knob. (Example of LEVEL Operation)

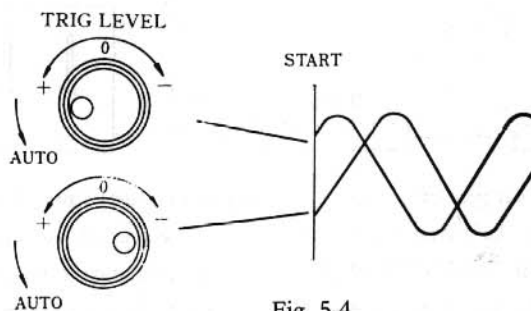
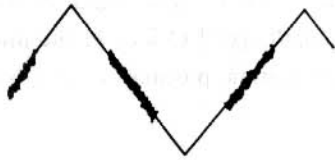

Fig. 5-4

If the LEVEL knob is turned as illustrated above, synchronization will be lost, or if no input signal is applied, bright lines (traces) on the screen will disappear as the sweep stops functioning. (These phenomena are inherent in a Trigger Oscilloscope.) Therefore, if LEVEL is set on an upper or a lower point of a waveform, even a slight change in the amplitude of the input signal can overrun a permissible range of fluctuation, causing the waveform to disappear from the screen. Namely, the sweep is halted. If it is difficult to obtain synchronization in the AUTO position, use LEVEL as shown below:

(Advantage of LEVEL)



AUTO. makes the sweep starting point unstable as shown above.

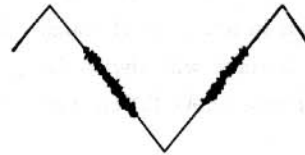

LEVEL and SLOPE make it possible to move the sweep starting point to obtain stable synchronization.

Fig. 5-5

5-4 Synchronization by EXT. TRIG. SOURCE

Although the TRIG. SOURCE is used normally with INT.; EXT. can also be utilized under certain conditions. The EXT. trigger is affected by a vertical axis input signal plus an additional synchronizing signal to the EXT. H or the TRIG. IN terminal. In this case, the frequency of the additional input signal must be the same as that of the vertical axis input signal or the two frequencies must have a whole number (integer) relationship.

Example of Use with a TV Set

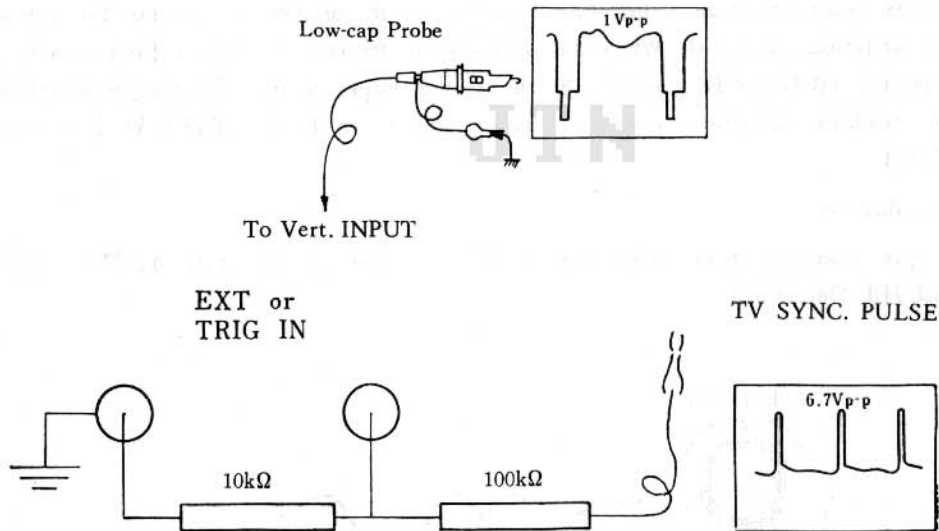

Fig. 5-6

In the observation of VIF detection output of complex or composite waveforms of a video amplifier, synchronization must be readjusted every time the signal changes its level. However, if only synch signals following synch separation from a TV set are added to the EXT. INPUT, then synchronization once attained will not be disrupted even if the magnitude of the vertical axis signal varies. (For Example, the point of measurement may be changed to another amplitude but the waveform will hold sync if a 0.1 – 2.0Vp-p signal is fed to the EXT. TRIG. IN (External Synchronizing Input) terminal. (If the signal is too great, attenuate the signal by means of a resistive network connected externally as shown above). In the case of horizontal pulses, just having a lead wire dangling inside the receiver will do for synchronization.

5-5 Synchronization To TV Waveforms

When the TIME/CM switch is set on the position of the TV. V range or TV. H range, the V or H sync. selector (Sync Separator) circuit readily functions on a composite video signal to present a stable waveform on the screen.

Push-in (-) when the sync. signal portion of the composite video signal is in lower part (negative polarity) and push-out (+) if it is in upper part (positive polarity).

For synchronization with a TV composite video signal, set the TIME/CM switch at the TV. V or TV. H position and push-in The TRIG mode to TV.

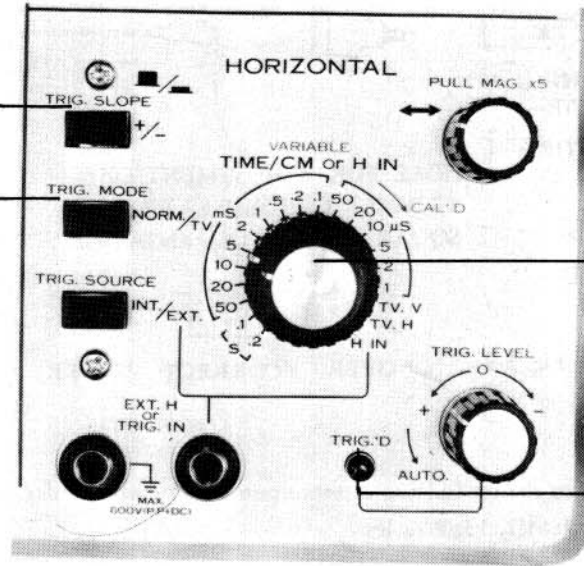

Pre-setting is arranged so that a TV wave form is shown over two cycles. (The VARIABLE (red knob) function is inoperative in this position)

Even if the lamp is Lit, synchronization is not attained when TRIG. SLOPE selection is improper.

Fig. 5-7

Note: Refer also to No. 18 in Item 4-1.

JTN

5-6 Voltage Measurement

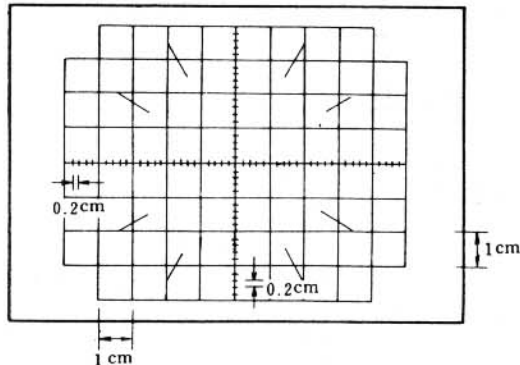
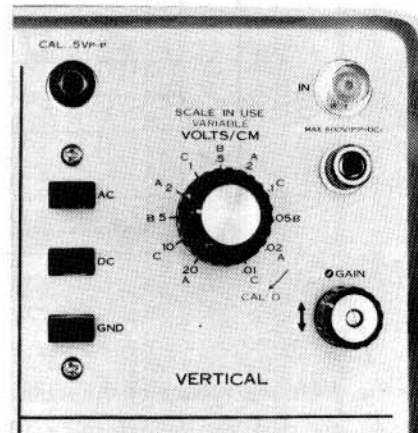

Fig. 5-8



The graticule scale is provided with 0.2CM and 1CM markings. When the VERTICAL VARIABLE (red knob) is turned fully clockwise till a click is heard, the CAL'D position is reached. The value indicated at the VOLTS/CM represents the value of voltage/CM of the display or waveform (peak value or DC value) and may be read directly from the scale.

5-6-1 Low Capacity Probe

When a low capacity probe (LPB-15X, LP-8X, etc.) is applied to the vertical axis INPUT, either the VOLTS/CM must indicate ten times the actual value or, conversely, measured voltages must be increased ten times. This applies to all measurements, either AC or DC, because the probe has a 10:1 attenuation factor.

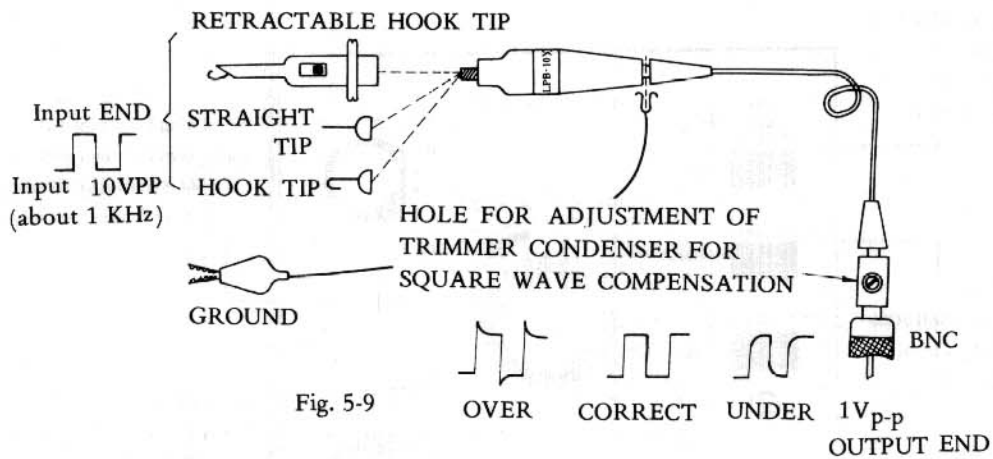

A lo-cap probe is used to reduce loading effects upon the circuitry under test. Input impedance when the lo-cap probe is used is $10M\Omega$, 15pF or less.

5-6-2 AC Voltage

The AC voltage is the variable portion remaining after the DC component is eliminated, e.g. pulses and sine waves.

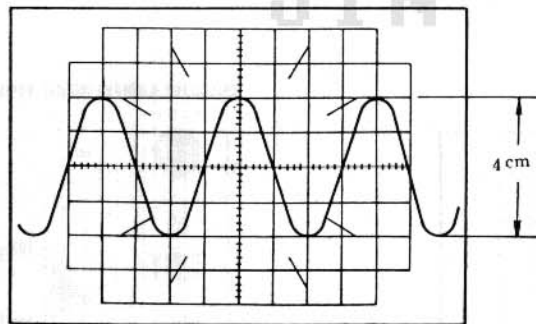

Fig. 5-10

As shown in Fig. 5-10, the voltage of the signal being measured is calculated as follows:

$$V = (\text{Amplitude observed on the screen}) \times (\text{Range indicated at the Volts/CM})$$

Therefore, $V = 4\text{CM} \times 0.05\text{V/CM} = 0.2\text{V(p-p)}$

The above represents an input signal fed by a lead wire directly to the INPUT (Input Terminal). The observed value must be increased ten times, if a low capacity probe of 10:1 attenuation type is used at the INPUT. (Example: Measurement using a lo-cap, 10:1 Probe)

VOLTS/CM: 0.2V/CM

Vertical Amplitude on the screen: 4CM

Probe: 10:1 low capacity type (LPB-15X, LP-8X, etc.)

$$V = (\text{Amplitude on the screen, CM}) \times (\text{VOLTS/CM, range}) \times (\text{Probe's magnification, 10})$$

$$\text{Therefore, } V = 4\text{CM} \times 0.2\text{V/CM} \times 10 = 8\text{V(p-p)}$$

If the input waveform is a sine wave, the measured voltage (p-p) can be converted to effective voltage (r.m.s.). The following relationship exists between the r.m.s. and the p-p values: $r.m.s. \text{ Voltage} \times 2\sqrt{2} = p-p \text{ Voltage}$ where $2\sqrt{2} = 2.828$

0.2Vp-p for instance, is converted to r.m.s. value as follows: $0.2V_{p-p} = \frac{1}{2\sqrt{2}} \times 0.2V \text{ r.m.s.} = 0.0707V$
 $r.m.s. = 70.7mV \text{ r.m.s.}$

5-6-3 DC Voltage

DC voltage is measured by observing the distance and the direction of the movement of the vertical position.

An upward shift of the bright line (trace) represents (+) and a downward shift (-).

VOLTS/CM: 2V/CM

TIME/CM: 0.1ms/CM

TRIG. LEVEL: AUTO. ↙

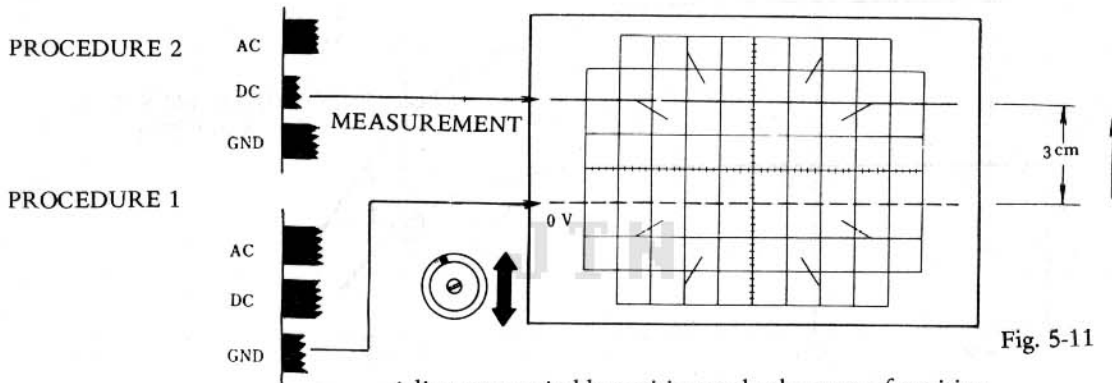

Fig. 5-11

Adjust to a suitable position and take note of position.
 This position represents 0V.

As shown above, the upward shift of the bright line (trace) indicates positive polarity. The value is obtained in the same manner as for the measurement of AC voltage, i.e.

$$V = +2V/CM \times 3CM = +6V$$

5-6-4 AC Voltage Containing DC Component

When it is desired to observe the distribution of DC voltage component within an AC wave form, the "DC" and the "GND" are used as in the case of the measurement of DC voltage.'

VOLTS/CM: 1V/CM

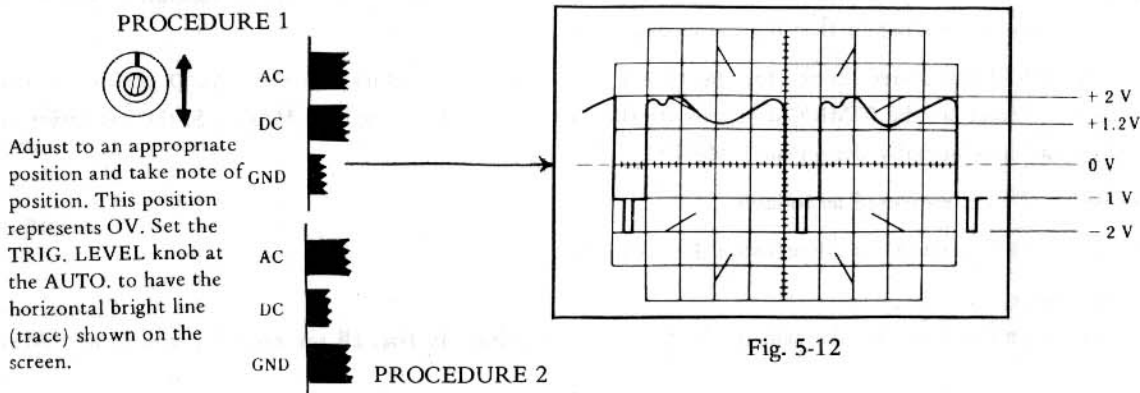

Fig. 5-12

Waveform will shift up or down from 0V. Amount of shift determines the value of D.C. Component. An upward shift represents a positive value; a downward shift represents a negative value.

Note: When the DC component is much greater than the AC content of the waveform, measurement by the procedures above will result in a very small waveform on the screen. Turning the VOLTS/CM range clockwise in an attempt to enlarge the waveform will merely let the DC component push the waveform off the screen making observation impossible.

5-6-5 High Frequency Voltage

In making high frequency voltage measurements careful consideration must be given to the frequency characteristics of the vertical axis amplifier of the LBO-502. When a sine wave input signal with a constant voltage is applied the vertical axis input terminal, amplitude shown on the screen decreases along with the frequency.

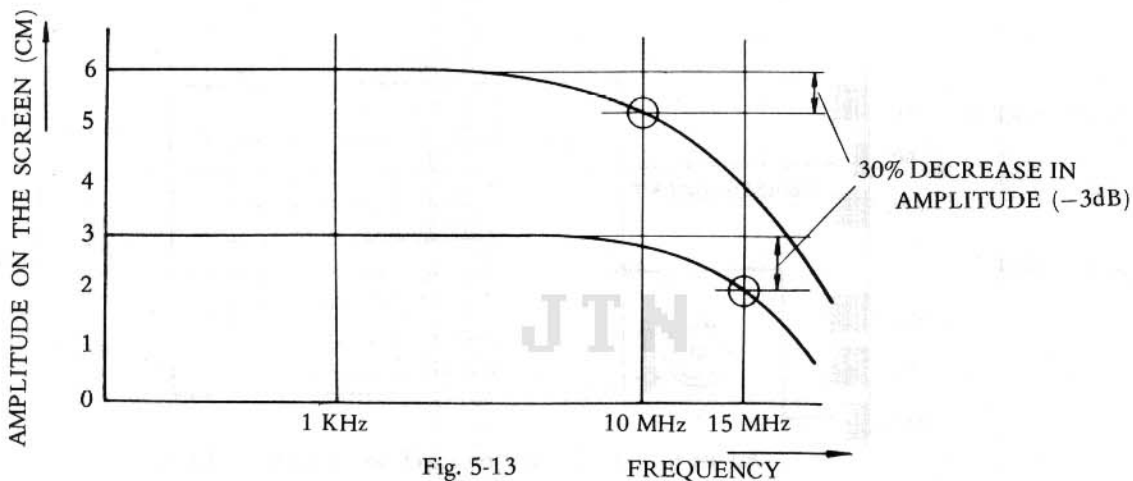

Fig. 5-13

For example, with an amplitude of 4.2CM on the screen, 1V/CM range and a frequency of 10MHz:

$$V = 4.2\text{CM} \times 1\text{V/CM} \times \frac{1}{1 - 0.3} = 6\text{V}$$

Further, high frequency measurement involves very small input capacities, the circuit being tested will be adversely affected unless input impedance is sufficiently high. For this reason, it is advisable to employ a low capacity probe.

5-7 Pulse Measurements

With a time axis incorporated, the width (T_w) or the rise time of a pulse can be measured directly on the screen in a manner similar to that for the measurement of voltage.

When the VARIABLE (red knob) for the time axis is turned fully clockwise the CAL'D position is reached, the value indicated at the TIME/CM represents time per CM. (If setting is at MAG \times 5, the indication will be one fifth the value actually shown on TIME/CM.)

Pulse width (T_w) is measured as follows:

$$T_w = (\text{TIME/CM range}) \times (\text{Horizontal Distance CM})$$

5-7-1 Magnifier

The Magnifier increases the gain of the horizontal amplifier by five, all the ranges of the TIME/CM switch,

i.e., TV-V, TV-H, EXT. H IN ranges, are operational.

This Magnifier is used for the detailed observation of a portion of a waveform. This is especially convenient when the enlargement of a portion of a waveform, away from its sync. sweep starting point, is desired.

Procedure 1
MAGNIFIER: X 1

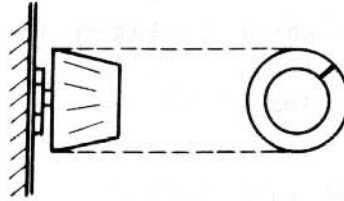

Push-in (normal)

PORTION BEING OBSERVED

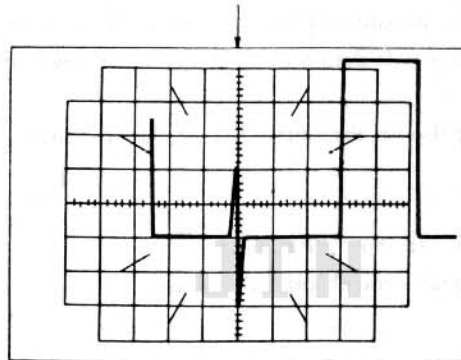

Procedure 2
MAGNIFIER: X 5

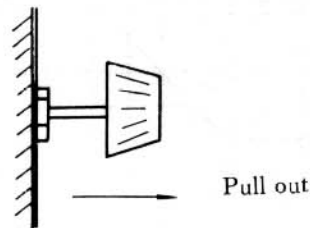

5 TIMES MAGNIFICATION
TO THE BOTH SIDES.

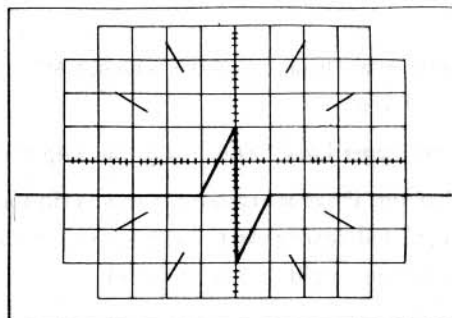

Fig. 5-14

Place the portion being observed on the center of the scale by means of the horizontal positioning knob.
 Note: When MAGNIFIER $\times 5$ is used, brightness is decreased. Furthermore, as only one fifth the normal size of a waveform is shown on the screen, the waveform is visible only intermittently in the case of slow sweep. Time must also be calculated based on one fifth the value measured. Unless otherwise required, always leave the MAGNIFIER at the $\times 1$ position.

5-7-2 Rise Time of Pulse

The rise time of a pulse is measured making use of the MAGNIFIER.

Procedure 1

TRIG SLOPE: — (Push-in)

MAGNIFIER: $\times 1$

Set TIME/CM so that the rising portion of the pulse is caught on the screen. Position the VARIABLE (red knob) to the end of its clockwise rotation.

Procedure 2

Position the pulse so that the flat portion is placed on the screen at a height with no fractional values, e.g. just 4cm or 6cm. (This is for easy calculation of 10% upper and lower deduction, when required.)

Procedure 3

Place the rising portion of the pulse on the center line of the scale by means of the horizontal positioning knob.

Procedure 4

Make certain the MAGNIFIER is set at $\times 5$ (Pull-out)

Shown below are examples of measurement and calculation:

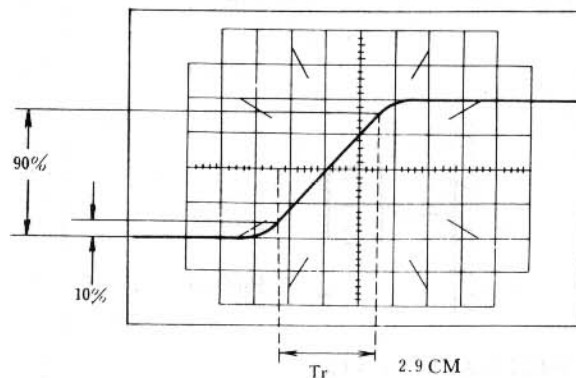

Fig. 5-15

Calculation of rise time;

$$Tr = (\text{TIME/CM range}) \times (\text{Horizontal Distance on the screen, CM}) \times (\text{Magnification Rate, } 1/5)$$

$$Tr = 2\mu\text{s/CM} \times 2.9\text{CM} \times 1/5 = 1.16\mu\text{s}$$

On the basis of this rise time, Tr , the upper limit frequency of the amplifier, f_c (-3dB), can be determined.

For instance, on the assumption that the above measurement was performed with input pulses which were fast enough and that the value calculated represents the output waveform of the amplifier being tested, then the upper limit frequency, f_c , of the amplifier can be found.

This is relationship to determine f_c (-3dB) from rise time of square wave pulse.

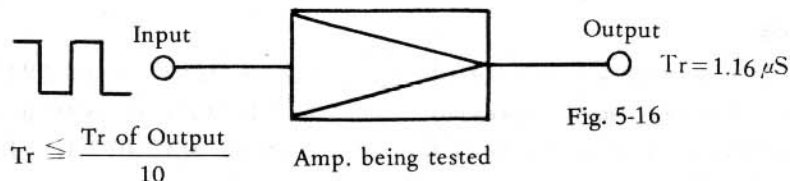

$$Tr \cong \frac{Tr \text{ of Output}}{10}$$

$$(fc = \frac{0.35}{Tr}) = \frac{0.35}{1.16 \times 10^{-6}} = 0.3 \times 10^6 = 300\text{kHz}, (-3\text{dB})$$

Units of time are enumerated below for reference:

Millisecond; ms = 10^{-3} Sec.

Microsecond; μs = 10^{-6} Sec.

Nanosecond; ns = 10^{-9} Sec.

Picosecond; ps = 10^{-12} Sec.

In the measurement of a comparatively fast pulse, the rise time of the LBO-502 must also be taken into consideration.

Rise time of The LBO-502; $T_a = 0.023 \mu\text{s}$

Rise time of the output of the amplifier being tested; T_i

Rise time observed on the screen; T_r

With this data, the true rise time T_i is calculated:

$$T_i = \sqrt{T_r^2 - T_a^2}$$

5-8 Frequency Measurement

Frequency can be calculated from one period of a repetitive wave form.

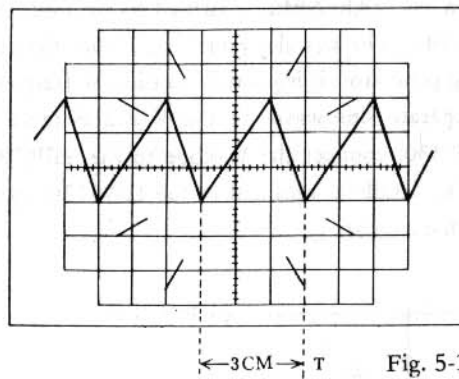

Time of 1 period is:

$$T = [\text{TIME/CM range}] \times [\text{Horizontal Distance of 1 period}] = 50\mu\text{s/CM} \times 3\text{CM} = 150\mu\text{s}$$

Frequency, f , is:

$$f = \frac{1}{T} = \frac{1}{150 \times 10^{-6}} = 0.67 \times 10^4$$

$$f = 6.7 \times 10^3 = 6.7\text{kHz}$$

Units of frequency are enumerated below for reference:

Kilohertz; kHz = 10^3 Hz

Megahertz; MHz = 10^6 Hz

Gigahertz; GHz = 10^9 Hz

5-9 TV-V and TV-H Range

The TIME/CM switch is provided with two special-purpose sweep ranges, TV-V and TV-H, for the convenience of servicing TV sets. These two ranges are preadjusted at 33.3ms/10CM and 127 μ s/10CM respectively, while the function of the VARIABLE is nullified. Since the function of the MAGNIFIER is left effective, it is still possible to magnify a specified point of a waveform for minute observation.

Also, as a TV sync. selector (sync. separator) circuit is built in, the observation of the waveform of a composite video signal is performed following the procedures as described in Item 5-5.

- Notes:
1. When the brightness of a TV picture makes a sudden change, the composite waveform shown on the screen may disappear for an instant due to the trigger signal being developed from a rapidly changing portion of the composite signal.
 2. In the case of circuits similar to color demodulators, if there are no horizontal sync. pulses present as shown here the T.V. sync. selector circuit will not function. The EXT. TRIG. SOURCE, if used as explained in Item 5-5, serves to present a locked in waveform without fail.

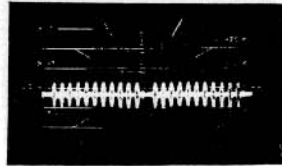

Fig. 5-18

5-10 EXT H IN

When the TIME/CM switch is set for the H IN range, the internal time axis circuit ceases to function and only the horizontal axis amplifier is operating. A signal may then be fed through the EXT H IN terminal.

MAG. $\times 5$ is also left effective, when the VARIABLE is turned to its limit, thus the deflection sensitivity of the horizontal axis is less than 200mV/CM. (The less the value, the higher the sensitivity.)

If used in combination with a sweep generator, it is possible to observe frequency response, or to display Lissajous figures on the screen by feeding separate sine waves to the V and H inputs. For combined use with a sweep marker generator, such as type LSW-330, connect the V scope to the VERTICAL INPUT and the H scope to the EXT. H IN and follow the rest of the details as outlined in the LSW-330 operation manual.

(Example of how to check Diode Characteristics)

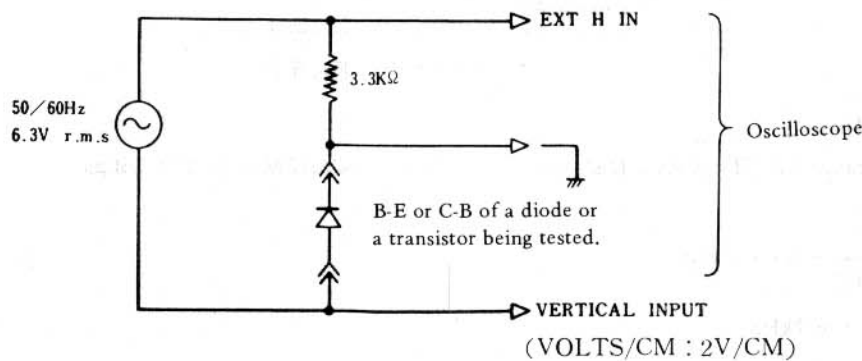
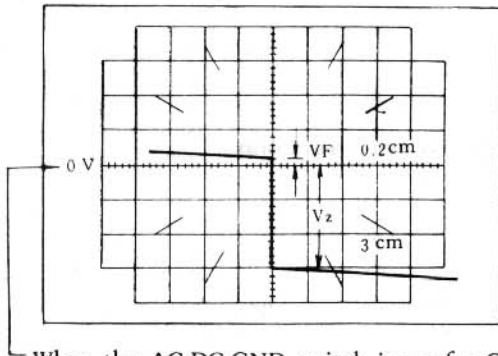

Fig. 5-19



From the waveform shown, Zener voltage V_z and forward voltage V_f can be calculated as follows:

$$V_f = 2\text{V/CM} \times 0.2\text{CM} = 0.4\text{V}$$

$$V_z = 2\text{V/CM} \times 3\text{CM} = 6\text{V}$$

Fig. 5-20

When the AC-DC-GND switch is set for GND, perform measurement after placing the bright line trace on this position by adjusting the \updownarrow knob.

Note: Determine the suitable values of AC voltage and series resistance, based on rated values of both forward and backward currents for the diode being tested.

5-11 VECTORSCOPE Application

5-11-1 Color TV Signal Checking: Gated Rainbow Method

The signals in a color TV set can be observed for checking and adjusting the circuits for color saturation, or amplitude, and color tint, or hue, when used with a color bar pattern generator. Suggested LEADER Color Pattern Generators are: LCG-388, -382, -384B, -386 and -381.

GATED RAINBOW PATTERN

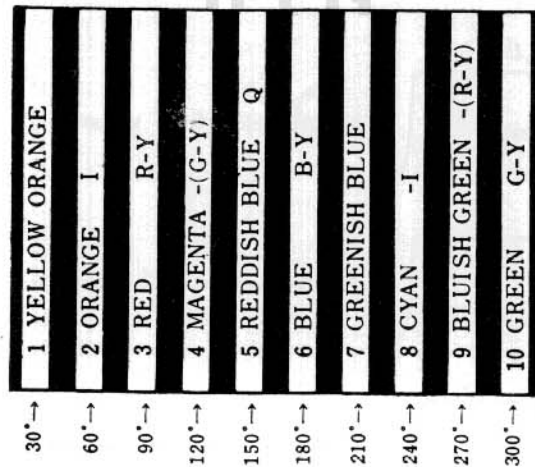

Fig. 5-21

The ten colors of the gated rainbow pattern are shown in Fig. 5-21.

Circuit adjustments can be made through observation of the respective waveforms as shown in Fig. 5-22.

Notes: Waveforms are shown for pickup at the CRT grids.

For cathode pickup (cathode modulation system), the waveform displays will be inverted.

The oscilloscope can be synchronized with the horizontal sync signal in the following manner: Set the TRIG SOURCE at "EXT". Connect a short insulated wire to the EXT TRIG IN terminal and hang this wire at a suitable place within the TV set to pick up the horizontal pulse signal by "static" coupling. The waveforms should be "near sinewave" in shape at the peaks; if not, then color saturation is indicated.

Waveforms at Grid Terminals (or at cathodes, with inverted display).

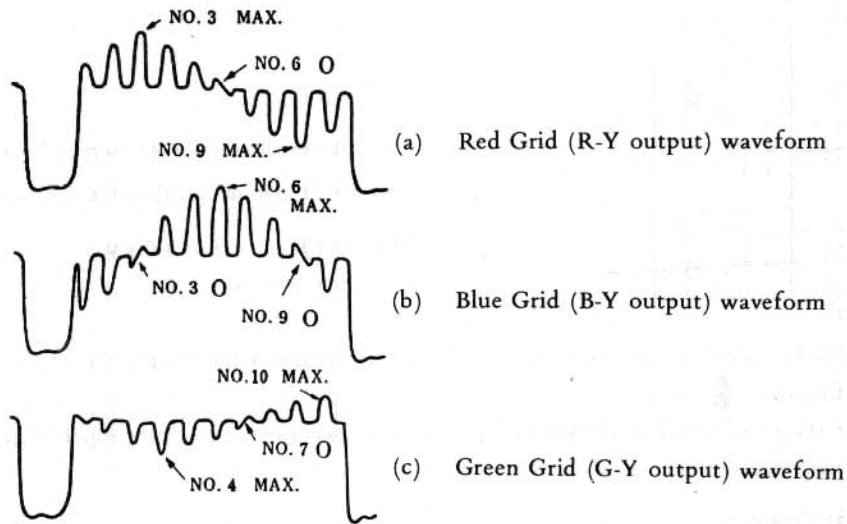

Fig. 5-22

In the rainbow pattern tests, if counting the peaks in the waveforms is tedious, use of LEADER Color Pattern Generator, LCG-388, is recommended. With use of this generator, the three respective waveforms will be displayed in the manner shown in Fig. 5-23.

R-Y, B-Y and -(G-Y) Waveforms using LCG-388

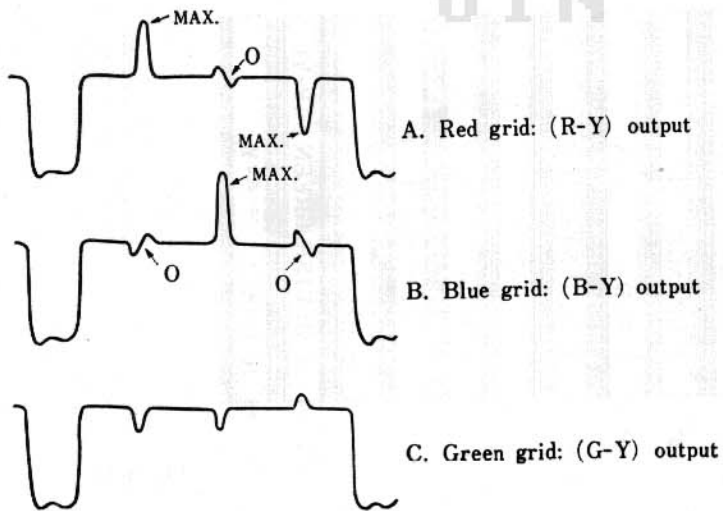

Fig. 5-23

5-11-2 Vector Display of R-Y and B-Y Signals

By connecting the R-Y and B-Y grids (or cathodes) respectively to the R-Y and B-Y terminals at back of the oscilloscope, the vector characteristic, Fig. 5-24, can be observed.

Phase relationship of the gated rainbow signals

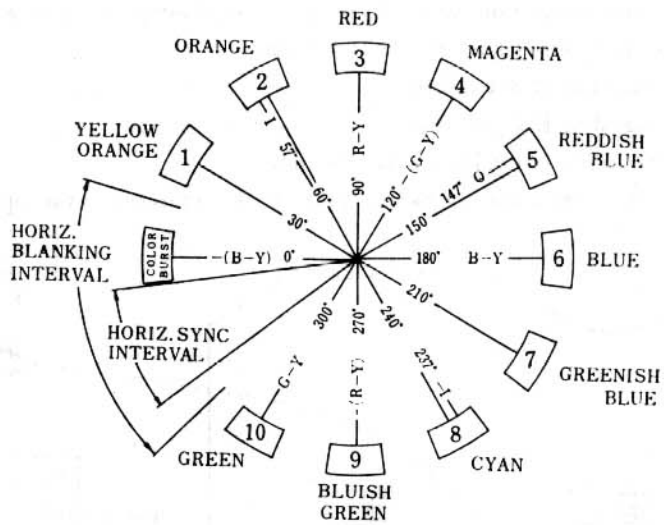

Fig. 5-24

The switch and control settings on the front panel for the vector display are shown in Fig. 5-25. Note that the settings are not used for vertical or horizontal inputs; only the positioning controls are to be used.

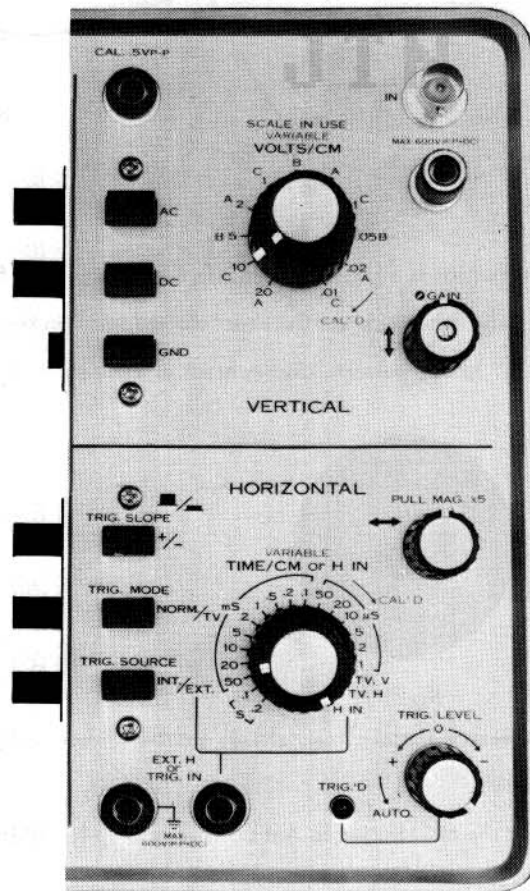

Fig. 5-25

The switch settings and input connections at the back of the oscilloscope are shown in Fig. 5-26.

Switch settings: Both slide switches at the VECTOR side.

Connections: R-Y signal to R-Y terminal.

B-Y signal to B-Y terminal.

INTEN MOD ground to chassis ground.

The gated rainbow signal from the color bar pattern generator is connected to the input of the color TV set.

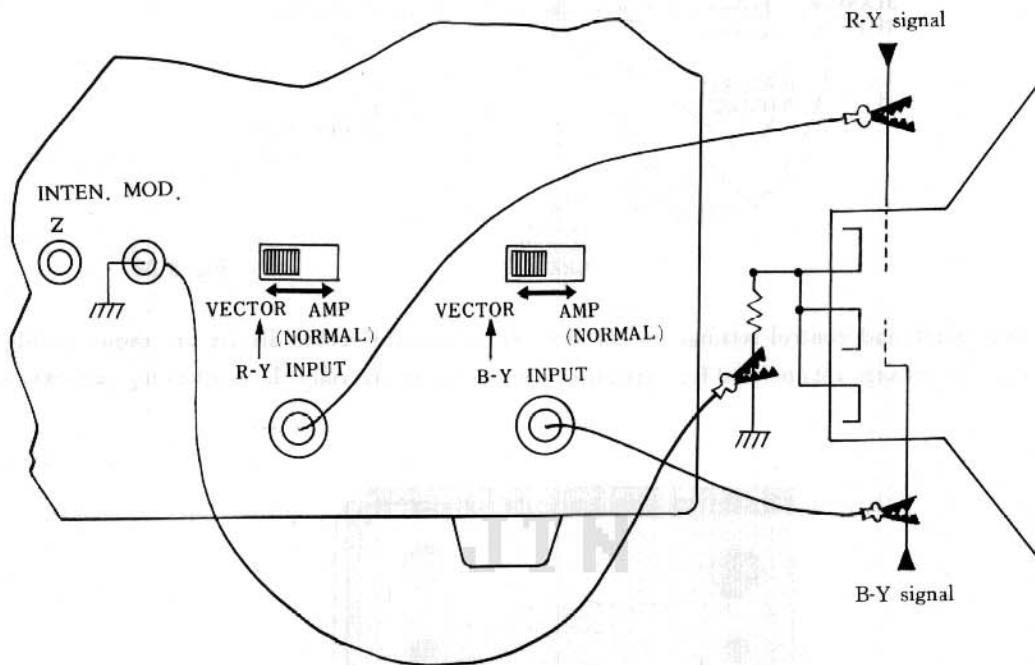

Fig. 5-26

When the tint (or hue) control in the set is adjusted, the pattern shown in Fig. 5-27 will be displayed.

Adjustments are made to properly align the peaks on the short slanted lines on the graticule.

If there is flattening of the "peaks" in the pattern, over-control or saturation is indicated.

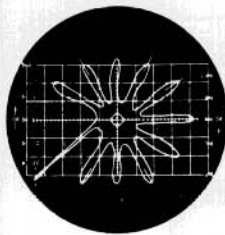

Fig. 5-27

IMPORTANT NOTE: After the vector pattern test, always set both slide switches at the AMP position.

5-12 Checking Modulation in AM Transmitters

The oscilloscope can be used in checking the modulation in AM transmitters up to 30MHz, with direct connections to the R-Y input. The deflection sensitivity is approximately 30Vp-p/cm.

PRECAUTION: Always turn off the transmitter power when connecting or disconnecting the leads.

A. Envelope Method.

The connections and switch settings are shown in Fig. 5-28. Note that the B-Y slide switch is at AMP. The sweep time depends on the audio modulation frequency; set for a two cycle display.

Setup for Envelope Method:

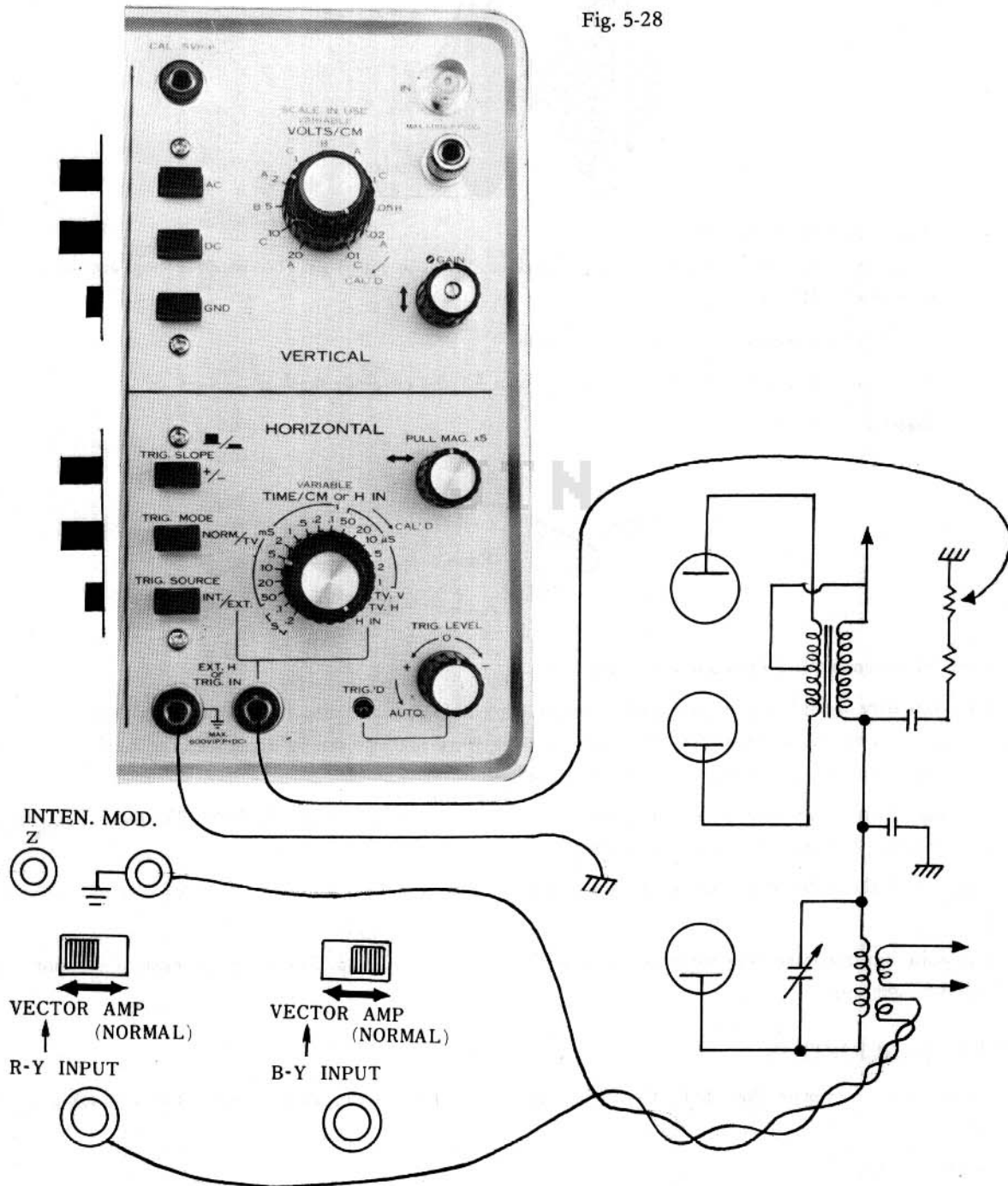

The degree of modulation is calculated from the following relation –

$$\text{Modulation in \%} = \frac{E_{\text{max}} - E_{\text{min}}}{E_{\text{max}} + E_{\text{min}}} \times 100$$

Where E_{max} and E_{min} are shown in Fig. 5-29.

Envelope Pattern:

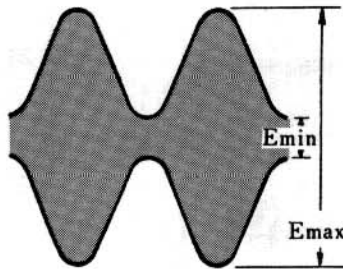

Fig. 5-29

B. Trapezoid Pattern Method.

In this method, the connections are the same as shown in Fig. 5-28. The switch settings are the same except that the TIME/CM is set at H IN.

The displayed pattern is shown in Fig. 5-30.

The degree of modulation is calculated as given for the envelope method.

Trapezoid Pattern:

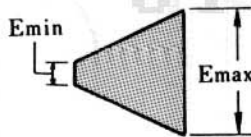

Fig. 5-30

5-13 Time Measurement and Frequency Marking

With intensity modulation of the CRT beam, it is possible to make time (period) measurements with use of an accurate external pulse generator. Furthermore, frequency markers can be applied to the response curves when the oscilloscope is used in circuit alignment procedures.

The signal, unknown time or detected sweep output, is connected to the INPUT. The panel controls are set for waveform observation or sweep operation.

Input from the pulse generator, or marker generator, is connected to the INTEN. MOD Z terminals on the rear panel.

The pulse input voltage required is in the range from 5Vp-p to 30Vp-p. Positive pulses create dark spots; negative pulses bright spots.

6. CIRCUIT DESCRIPTION

The circuits which comprise the LBO-502 will be described briefly in this section. Refer to the block diagram and schematic.

6-1 Vertical Input

The signal under examination at the INPUT connector is applied to the AC-DC-GND Push switch for AC

coupling through a blocking capacitor or is directly coupled (DC). A 11 step attenuator is used to lower the input voltage to suitable levels for amplification. The input voltage in volt per CM deflection is adjusted by suitable combination of four frequency-compensated attenuator pads.

6-2 Amplifiers

6-2-1 Vertical Preamplifier

The signal from the input attenuator is fed to FET Q403 by way of the input protection circuit of Q401 and Q402. After the high input impedance of the input is converted to a low impedance at Q405, it becomes a balanced output signal through Q407 and Q408.

Q404 and Q406 act as a temperature compensation circuits to cancel direct current drift.

6-2-2 Horizontal

The operational amplifier configuration, Q803~Q805 is used in the horizontal deflection stage. The amplification is dependent on the ratio of the feedback and input resistances. The amplitude of the horizontal signals, namely, the sawtooth voltage for the time base and preamplifier output are preset or controlled with adjusters and variable resistors.

The amplifier is single-ended and another identical stage, Q806~Q808 with unity gain is used as a phase inverter for pushpull deflection.

The preamplifier, Q801~Q802 for external horizontal input or triggering signals uses the Darlington circuit for impedance conversion. The input is AC coupled and includes a diode for protection against voltage overload.

The X 5 magnification raises the gain by a factor of five. The spot position is adjusted by varying the bias on the base of Q803

6-3 Time Base

Control of the triggered sweep with calibrated speeds is accomplished as follows. A triggered signal from the input is picked off at Q408 in the vertical amplifier and through the buffer Q411 then to the polarity changer Q601-Q604. The external triggering is applied from the EXT H or TRIG. IN jack. The TRIG LEVEL control, VR603, is for control at any chosen portion of the slope of the triggering waveform. The direction is selected with the TRIG SLOPE switch S601.

A Schmitt trigger with Q605-Q606 is used for waveshaping and generation of sharp pulses. These pulses are applied to the sweep gating and switching multivibrator made up of Q612-Q613.

Sawtooth waveforms are generated by the Miller integrator consisting of Q615-Q617, D610, D611. The TIME/CM switch controls the sweep timing in μ s, ms and second per CM., TV-V and TV-H by selection of the different RC combinations. The controlled sweep is then fed to the horizontal deflection amplifier.

The holdoff circuit with Q618, Q619, is used to start the sweep with the trigger signal and will keep the sweep in action, i.e., until the sweep is stopped as determined by the preset LENGTH adjuster VR608. The sweep is prevented from starting, or being triggered, until the sweep voltage has dropped to zero.

The pulse for unblanking is picked off at the multivibrator output by Q614. In use, the pulse extinguishes the beam when there is no sweep action due to absence of the triggering signal. When the signal is applied to the

intensity control circuit of the CRT. the trace is displayed.

When set to AUTO and the trigger pulse is not generated at the trigger shaper, the one-shot multivibrator consisting of Q608 and Q609 will be OFF for Q609, OFF for Q610 and ON for D606 lowering the STABILITY presetting of VR606, thus the sweep loop made up of Q612 to Q618 will be free running.

When trigger pulse is generated at the trigger shaper, the pulse will be added to the one-shot multivibrator through Q607.

Q609 turns on only when the pulse arrives, because of the time constant of C612 and R624 to R626 in the collector circuit of Q609.

Then, Q610 turns ON, D606 turns OFF, and VR606 returns to its initial triggered sweep condition.

6-4 CRT Section

The CRT, V101, is a 5-inch flat-face type operated with an accelerating potential of 1800V.

To intensity the beam only when the sweep is in operation, unblanking action is used. The control signal from Q614 is amplified to apply approximately 160Vp-p to grid No 1 of the CRT.

Voltage Calibrator

The 0.5 Vp-p voltage used in calibration of the vertical sensitivity is generated with a multivibrator Q904-Q905. The square waveform, at 1kHz is fed to the amplifier Q906. The output voltage is taken off adjuster VR901 at the collector circuit.

Power Supplies

The following power supplies are used in the operation:

TYPE	OUTPUT Voltage	USE
Regulated	+12V	} Vertical Preampfier Amplifier, time base, Voltage calibrator
	+27V	
	-27V	
Unregulated	-1600V	CRT acceleration voltage Vertical Output Amplifier Vertical output amplifier, Unblanking circuit, Astigmatism adjuster, CH-1, CH-2 and TRIG'D LAMP. Horizontal Amplifier
	-40V	
	+210V	
	+320V	

CHART 6-1

7. MAINTENANCE

7-1 General

In this section, the performance checks and the internal adjustments, when required, will be described.

Precautions:

1. Checks should be made after a 30 minute warmup.
2. Care must be exercised not to come in contact with the high voltage, 1800V approximately, when checking the CRT circuit.

7-2 Exposing the Chassis

The covers are removed by unscrewing the 11 screws which hold them to the frame.

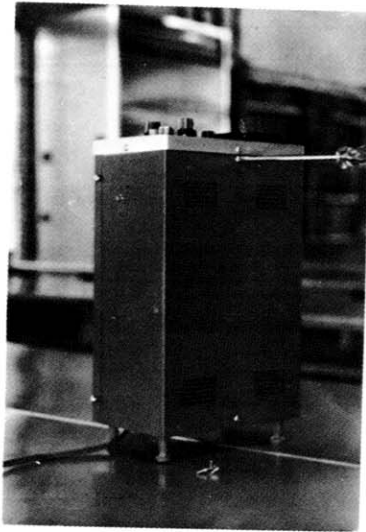

Fig. 7-1

Removing the cover screws.

7-3 Location of Adjusters and Test Points

On the inside of the top and bottom covers, labels are pasted which indicate the location of the different adjusters and test points. Prefix "TP" indicates the test points.

(LBO-502 MAIN label)

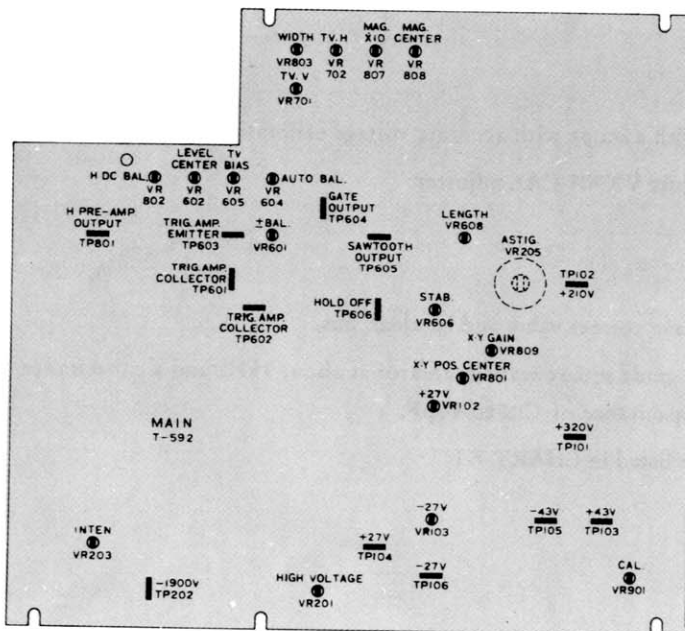

Fig. 7-3

(Attenuator Trimmers, top view label)

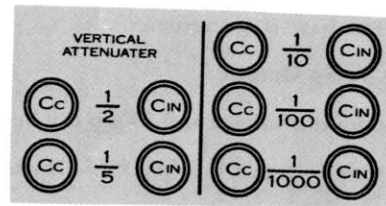

Fig. 7-2

(LBO-502 V-AMP label)



Fig. 7-4

7-4 CRT Circuit

7-4-1 Limited control of spot intensity

If the spot cannot be extinguished or made to appear with the INTENSity control, check the following voltages and adjust if necessary.

TEST POINT	VOLTAGE, V		ADJUSTER
TP 104	+27	±2	VR102
TP 106	-27	±2	VR103
TP 202	-1600	±100	

Assuming that the voltages are proper, set the controls as follows:

INTENSity as shown at the right
TRIG LEVEL to AUTO (switched)
TIME/CM to 5 ms

Set the INTEN adjuster to a suitable brightness of the spot.

INTEN

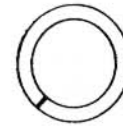

7-4-2 Sloping of the horizontal trace

When the axis of the CRT is oriented 360° in the horizontal plane, there may be a slight sloping of the trace from the horizontal, about 1 to 2mm per 10cm. This amount can be corrected by Scale tilt knob. (If the sloping is great, then the CRT must be repositioned by loosening the clamp at front of the CRT. CARE!! High voltage, -1800 approx., is present at the INTENSity and FOCUS controls and caution must be exercised.)

7-4-3 Proper focussing cannot be achieved

If at the operating intensity, the vertical or horizontal display is not clear, adjustment is made with the ASTIGmatism adjuster VR205.

NOTE that when adjusted, there is possibility of a slight change, about 1%, in the vertical amplifier and time base characteristics.

7-5 CAL 0.5Vp-p Output

The calibration voltage at 0.5Vp-p can be checked with a scope with accurate voltage calibration.

The proper voltage is 0.5Vp-p ±3%. If necessary, adjust VR901 CAL adjuster.

7-6 Vertical Amplifier Circuit

7-6-1 Improper Square Wave Display

The display of the square wave input should have correct value and be clean cut.

If not, adjustments must be made using a lab grade square wave generator at about 1kHz and a capacitance meter. The latter is used to adjust the input capacitance of C_{IN} to 40pF.

Trimmers for the different attenuator pads are listed in CHART 7-1.

CHART 7-1 ATTENUATOR TRIMMERS

PAD	C _c	CIN
1/2	VC301	VC302
1/5	VC303	VC304
1/10	VC305	VC306
1/100	VC307	VC308
1/1000	VC309	VC310

Refer to 7-3 for location of trimmers

Adjust according to the steps in CHART 7-2.

CHART 7-2 ORDER OF TRIMMER ADJUSTMENTS

STEP	VOLTS/CM SETTING	TRIMMERS	
		SQUARE WAVE C _c	FOR 40PF INPUT CAPACITANCE G _n
1	0.01	—	
2	0.02	VC301	VC302
3	0.05	VC303	VC304
4	0.1	VC305	VC306
5	0.2, 0.5	CHECK ONLY	
6	1	VC307	VC308
7	2, 5	CHECK ONLY	
8	10	VC309	VC310
9	20	CHECK ONLY	

NOTES: 1. The order of the steps must not be changed.

2. If equipment for the 40pF input capacitance measurement is not available, adjust the C_c trimmer only.

7-6-2 Vertical shift when VOLTS/CM switch is changed.

Control settings for check:

AC-DC-GND switch to GND.

TRIG. LEVEL Knob to AUTO (switched).

Short the VERTICAL INPUT to ground.

Rotate the VOLTS/CM from 0.01 to 0.1 cm

The vertical shift tolerance should be less than 10mm. If the shift is less than about 5mm but affects the measurements, correction can be made with the gate current adjuster VR401

If the shift is over 5mm, leakage of the order of 5nA may be present in the input circuit caused by extremely high humidity conditions. Check by drying with forced hot air on the attenuator components. If the trouble persists, replacement of components may be necessary.

7-6-3 Vertical shift when VARIABLE of VOLTS/CM is rotated.

Control settings for check:

- AC-DC-GND switch to GND.
- TRIG. LEVEL Knob to AUTO (switched).
- Rotate the VARIABLE control.

The shift should not exceed 10mm.

If the shift is over this amount and affects the measurements, adjustments are required. Note, however, that the sensitivity and bandwidth characteristics are not affected.

- STEP 1 Set the VARIABLE knob to fully clockwise. Note the position of the trace on the scale.
- STEP 2 Set the VARIABLE knob to fully counterclockwise.
- STEP 3 Adjust VR404 DC BAL adjuster to return the trace to the position in STEP 1.
- STEP 4 Repeat STEPS 1, 2 and 2 as required to produce a no shift condition.

7-6-4 Compression of vertical trace

When the displayed waveform is distorted by compression, or "clipping effect" at the peaks, regardless of the vertical positioning control, it is an indication of improper bias on the input FET's Q403 and Q404.

Assuming that the FET's are functioning properly, voltage at TP401 and TP402 should be 0.5V. If not within $\pm 0.3V$ of 0.5V, adjust VR402 and/or VR403. (The voltmeter must have a resistance of 10k Ω or higher on the range used.)

The voltage at the two points must be the same, otherwise the DC balance is upset and requires an adjustment of VR404 as mentioned in the previous section, 7-6-3.

When replacing the FET's Q403 and Q404, a matched pair must be selected in which the drain current I_{DSS} is within $\pm 10\%$. Typical I_{DSS} is 5mA at $V_{GS} = 0V$ and $V_{DS} = 10V$.

7-7 Time Base Circuit

7-7-1 No sync action or no display.

Control setting for check:

TIME/CM switch to 5 ms.

- Faults:
1. Trace cannot be extinguished when the TRIG LEVEL control is rotated fully in the + or - direction.
 2. Trace does not appear when the TRIG LEVEL switch is set to AUTO (switched).

Adjustments:

- STEP 1. Control settings
 - TIME/CM switch to 5 ms.
 - AC-DC-GND switch to AC.
 - 0.5Vp-p CAL connect to V IN and VOLTS/CM Switch to 0.1V.

- STEP 2. Rotate the TRIG LEVEL control to full + or - direction and set VR606 STAB adjuster to the point where the trace just appears.
Note this setting.
- STEP 3. Set the TRIG LEVEL control to "O" (Center) and set VR606 adjuster to the point where the trace just disappears.
Note this setting.
- STEP 4. Finally, set VR606 at the position midway between the settings.

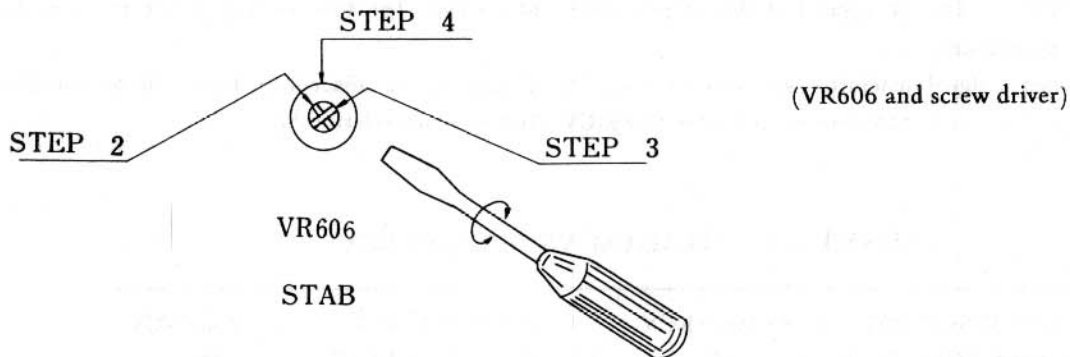

Stability adjustments.

Fig. 7-5

7-7-2 AUTO TRIG. is hard to synchronize.

When the TRIG. LEVEL knob is set to "O", a sine wave of about 1kHz should synchronize correctly at less than 10mm with the SLOPE + or -. If it does not, adjust VR604 and AUTO BAL. so that the sine wave of about 1kHz will synchronize within 5 to 10mm even if the SLOPE is switched to + or - when AUTO is set.

7-7-3 TV synchronization is hard to synchronize.

Check whether the AUTO synchronization is being performed correctly or not. If it is not synchronizing within an amplitude of less than 10mm, correct it in accordance with the procedure of the above section 7-7-2. and make check again.

Then, adjust VR605 and TV bias so that synchronization of the TV signal occurs even when AUTO is set.

If possible, it would be best to check both positive and negative polarities.

7-7-4 Sweep timing incorrect on all ranges.

An accurate time marker or a wideband signal generator is required for checking.

When there is an error of more than $\pm 5\%$ in timing on all ranges, adjust VR803 WIDTH adjuster.

As shown below, the 11th pulse must lie exactly on the 11th vertical line. If the pulse is $\pm 5\text{mm}$ off, the error is $\pm 5\%$.

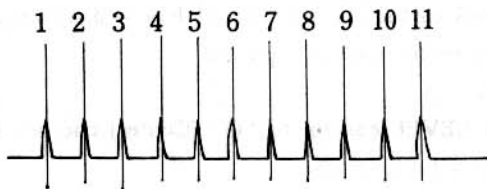

Timing pulse display. Fig. 7-6

In the calibration procedure, VR803 WIDTH adjuster must be set at the point where pulses in the range 0.2ms to 1 μ s are applied at the proper TIME/CM settings. The final setting of VR803 is made at the average point.

When a signal generator (sine wave) is used for calibration, the adjacent peaks will lie on one division of the scale; refer to CHART 7-3 for the TIME/CM VS. frequency relationship.

CHART 7-3 TIME/CM VS. FREQUENCY

TIME/CM SETTING AND TIME PER CYCLE	FREQUENCY Hz	TIME/CM SETTING AND TIME PER CYCLE	FREQUENCY Hz
0.2 s	5	0.5 ms	2 k
0.1 s	10	0.2 ms	5 k
50 ms	20	0.1 ms	10 k
20 ms	50	50 μ s	20 k
10 ms	100	20 μ s	50 k
5 ms	200	10 μ s	100 k
2 ms	500	5 μ s	200 k
1 ms	1 k	2 μ s	500 k
		1 μ s	1 M

7-7-5 Sweep timing incorrect on 20-10-5 μ s and 2-1 μ s ranges only.

When only these ranges are incorrect in timing, adjustments are made in the same manner as for the 11 - pulses display given in Section 7-7-4 above.

CHART 7-4

RANGE	ADJUSTER
20-10-5 μ s	VC701
2-1 μ s	VC702

TV-V and TV-H width adjustment.

At each setting of the TIME/CM switch, two cycles of the respective TV signals should cover 10cm.

If there is a discrepancy, adjustment is made as shown below.

CHART 7-5

SETTING	ADJUSTER
TV - V	VR704
TV - H	VR705

Use of two input signals, TV and pulse,

TV SIGNAL INPUT

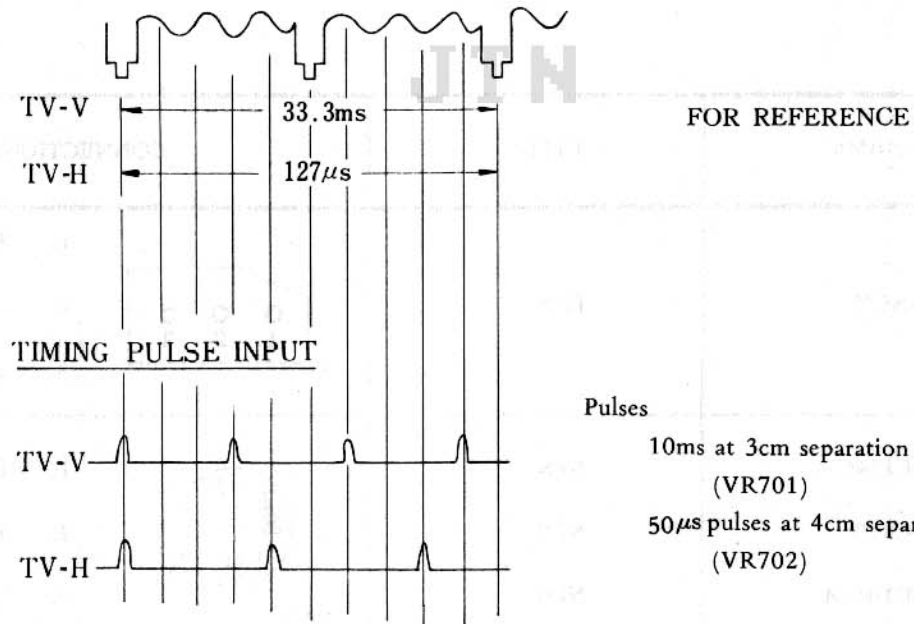

TV-V and TV-H adjustments.

Fig. 7-7

7-7-6 MAG X 5 adjustments.

A. Calibration is off:

When the sweep is not magnified (expanded) properly at Five times, adjust VR807 the MAG X 5 adjuster.

B. Trace shift at MAG X 5 :

When the portion of the display is centered on the scale but shifts in position by 2 or 3cm when the button is pushed, adjust VR808 theMAG CENTER adjuster for centering.

7-7-7 Horizontal shift when VARIABLE at EXT H IN is adjusted.

Set the Mag X 5 .

If the trace shifts by more than 2 or 3cm, set VR802 DC BAL adjuster to the point where the shift is eliminated, or minimized.

8. PIN CONNECTIONS, TRANSISTORS AND CRT

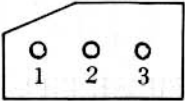
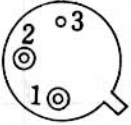
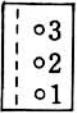
NAME	TYPE	CONNECTIONS
2SA678	PNP	 <ul style="list-style-type: none"> 1. Emitter 2. Collector 3. Base
2SC154C 2SC423 2SC1012A	NPN	 <ul style="list-style-type: none"> 1. Emitter 2. Base 3. Collector (case)
2SC458	NPN	 <ul style="list-style-type: none"> 1. Emitter 2. Collector 3. Base

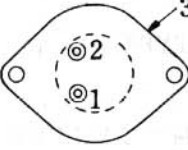
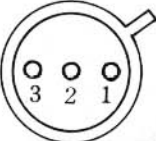
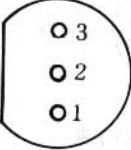
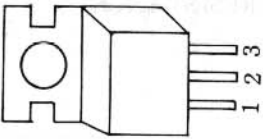
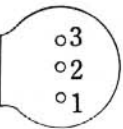
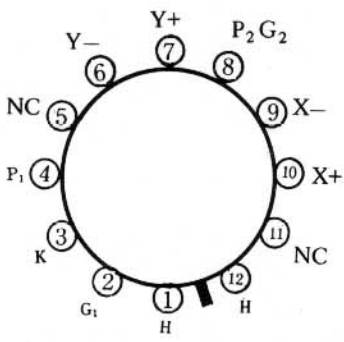
2SC499	NPN		<ol style="list-style-type: none"> 1. Emitter 2. Collector 3. Base
2SC685A/515 2SC508 2SD150	NPN NPN NPN		<ol style="list-style-type: none"> 1. Base 2. Emitter 3. Collector (case)
2SC645	NPN		<ol style="list-style-type: none"> 1. Emitter 2. Collector 3. Base
2SC869	NPN		<ol style="list-style-type: none"> 1. Base 2. Collector 3. Emitter
2SD235	NPN		<ol style="list-style-type: none"> 1. Base 2. Collector 3. Emitter
2SK34	FET		<ol style="list-style-type: none"> 1. Source 2. Gate 3. Drain
130ARB1	CRT		

9. TRANSISTOR CHECKING

Transistors can be checked quickly with an ohmmeter, using the $R \times 100$ or $R \times 1000$ range. (Disconnect the power supply.)

By considering transistor as two diodes with a common connection, tests can be made in the same manner as when determining the quality and diodes.

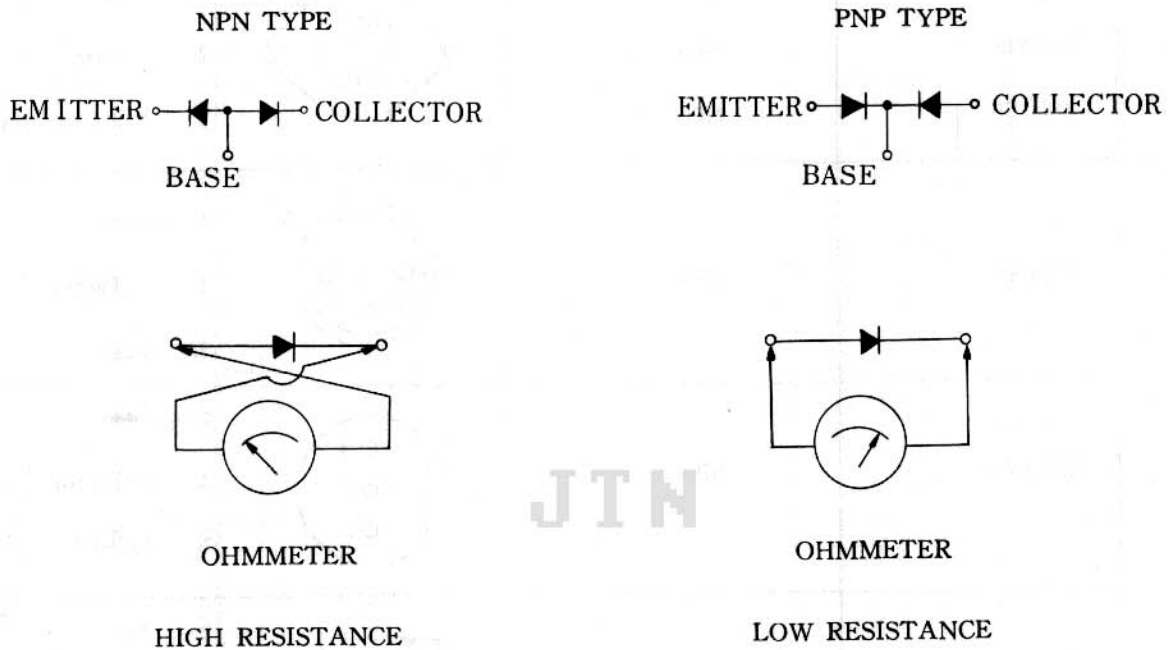
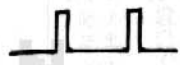

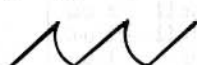

Fig. 9-1

Condition for a good transistor.

10. VOLTAGE AND WAVEFORM CHART

TP No.	VOLTAGE AND WAVEFORM
TP101	+320V
TP102	+210V
TP103	+43V
TP104	+27V
TP105	-42V
TP106	-27V
TP202	-1600V
TP401	+0.5V
TP402	+0.5V
TP403	+12V
TP601	-7.6V
TP602	-7.6V
TP603	-19V
TP604	 2Vp-p
TP605	 12Vp-p
TP606	 8Vp-p
TP801	+0.2V

11. NAME AND NUMBER OF PCB's

NAME	No.
V AMP	T-664
V FINAL	T-588A
MAIN	T-592
V ATT	T-663
HV RECT	T-666
VECTOR	T-294A
PILOT	T-665

SCH. No.	Symbol No.	Description			LEADER Parts No.	Note
RESISTORS						
1	R101	Carbon film 1/2W	330Ω	±10%	RD1/2PSZK 330Ω	
1	R102	Carbon film 1/2W	56Ω	±10%	RD1/2PSZK 56Ω	
1	R103	Carbon film 1/2W	47Ω	±10%	RD1/2PSZK 47Ω	
1	R104	Carbon film 1/4W	1KΩ	±5%	RD1/4PNYJ 1KΩ	
1	R105	Carbon film 1/4W	4.7KΩ	±5%	RD1/4PNYJ 4.7KΩ	
1	R106	Carbon film 1/4W	1.8KΩ	±5%	RD1/4PNYJ 1.8KΩ	
1	R107	Carbon film 1/4W	4.7KΩ	±5%	RD1/4PNYJ 4.7KΩ	
1	R108	Carbon film 1/4W	1.8KΩ	±5%	RD1/4PNYJ 1.8KΩ	
1	R109	Carbon film 1/2W	220Ω	±10%	RD1/2PSZK 220	
1	R110	Carbon film 1/2W	47Ω	±10%	RD1/2PSZK 47Ω	
1	R111	Carbon film 1/4W	1KΩ	±5%	RD1/4PN YJ 1KΩ	
1	R112	Carbon film 1/4W	4.7KΩ	±5%	RD1/4PNYJ 4.7KΩ	
1	R113	Carbon film 1/4W	4.7KΩ	±5%	RD1/4PNYJ 4.7KΩ	
1	R114	Carbon film 1/4W	4.7KΩ	±5%	RD1/4PNYJ 4.7KΩ	
1	R115	Carbon film 1/4W	150KΩ	±5%	RD1/4PNYJ 150KΩ	
1	R117	Carbon film 1/2W	5.6Ω	±10%	RD1/2PSZK 5.6Ω	
1	R118	Carbon film 1W	18Ω	±10%	RD1SPZK 18Ω	
2	R201	Carbon film 1/2W	47KΩ	±10%	RD1/2PSZK 47KΩ	
2	R202	Carbon film 1/2W	68KΩ	±10%	RD1/2PSZK 68KΩ	
2	R203	Carbon film 1/2W	1MΩ	±10%	RD1/2PSZK 1MΩ	
2	R204	Carbon film 1/2W	33KΩ	±10%	RD1/2PSZK 33KΩ	
2	R205	High Meg. 1W	1.5MΩ	±10%	HM1PK 1.5MΩ	
2	R206	Carbon film 1W	1.5MΩ	±10%	RD1PYJ 1.5MΩ	
2	R207	Carbon film 1W	1.5M	±10%	RD1PYT 1.5MΩ	
2	R208	Carbon film 1W	1.5MΩ	±10%	RD1PYT 1.5MΩ	
2	R209	Carbon film 1W	1.5MΩ	±10%	RD1PYJ 1.5MΩ	
2	R210	Carbon film 1/4W	47KΩ	±5%	RD1/4PNYJ 47KΩ	Factory Adj.
2	R211	Carbon film 1/4W	27KΩ	±5%	RD1/4PNYJ 27KΩ	
2	R212	Carbon film 1/4W	100Ω	±5%	RD1/4PNYJ 100Ω	
2	R213	Carbon film 1/2W	47KΩ	±10%	RD1/2PSZK 47KΩ	
2	R214	Carbon film 1/2W	68KΩ	±10%	RD1/2PSZK 68K	
2	R215	Carbon film 1/2W	68KΩ	±10%	RD1/2PSZK 68K	
2	R216	Carbon film 1/4W	33K	±5%	RD1/4PNYJ 33K	
2	R217	Carbon film 1/4W	2.2K	±5%	RD1/4PNYJ 2.2K	
2	R218	High Meg. 1W	3.6MΩ	±10%	HM1PK 3.6MΩ	
2	R219	High Meg. 1W	3.3MΩ	±10%	HM1PK 3.3MΩ	
2	R230	Carbon film 1/2W	1MΩ	±10%	RD1/2PSZK 1MΩ	
2	R231	Carbon film 1/2W	1MΩ	±10%	RD1/2PSZK 1MΩ	
2	R232	Carbon film 1/2W	1MΩ	±10%	RD1/2PSZK 1MΩ	
2	R233	Carbon film 1/2W	1MΩ	±10%	RD1/2PSZK 1MΩ	
2	R234	Carbon film 1/2W	1MΩ	±10%	RD1/2PSZK 1MΩ	
2	R235	Carbon film 1/2W	1MΩ	±10%	RD1/2PSZK 1MΩ	Factory Adj.
2	R236	Carbon film 1/2W	4.7KΩ	±10%	RD1/2PSZK 4.7KΩ	
2	R237	Carbon film 1/2W	2.2MΩ	±10%	RD1/2PSZK 2.2MΩ	
2	R238	Carbon film 1/2W	2.2MΩ	±10%	RD1/2PSZK 2.2MΩ	
2	R239	Carbon film 1/2W	2.2MΩ	±10%	RD1/2PSZK 2.2MΩ	
2	R240	Carbon film 1/2W	2.2MΩ	±10%	RD1/2PSZK 2.2MΩ	
2	R241	Carbon film 1/2W	2.2MΩ	±10%	RD1/2PSZK 2.2MΩ	
2	R242	Carbon film 1/2W	2.2MΩ	±10%	RD1/2PSZK 2.2MΩ	
2	R243	Carbon film 1/2W	2.2MΩ	±10%	RD1/2PSZK 2.2MΩ	
2	R244	Carbon film 1/2W	2.2MΩ	±10%	RD1/2PSZK 2.2MΩ	
2	R245	Carbon film 1/2W	1MΩ	±10%	RD1/2PSZK 1MΩ	
2	R246	Carbon film 1/2W	1MΩ	±10%	RD1/2PSZK 1MΩ	
2	R247	Carbon film 1/2W	1MΩ	±10%	RD1/2PSZK 1MΩ	
2	R248	Carbon film 1/2W	150KΩ	±10%	RD1/2PSZK 150KΩ	
2	R249	Carbon film 1/4W	1KΩ	±5%	RD1/4PNYJ 1KΩ	
2	R250	Carbon film 1/4W	22KΩ	±5%	RD1/4PNYJ 22KΩ	
3	R301	Metal film 1/2W	500KΩ	±0.5%	EF1/2D 500KΩ	
3	R302	Metal film 1/2W	1MΩ	±0.5%	EF1/2D 1MΩ	
3	R303	Metal film 1/2W	800KΩ	±0.5%	EF1/2D 800KΩ	
3	R304	Metal film 1/2W	250KΩ	±0.5%	EF1/2D 250KΩ	

SCH. No.	Symbol No.	Description	RESISTORS		LEADER Parts No.	Note
3	R305	Metal film 1/2W	900K Ω	$\pm 0.5\%$	EF1/2D 900K Ω	
3	R306	Metal film 1/2W	111K Ω	$\pm 0.5\%$	EF1/2D 111K Ω	
3	R307	Metal film 1/2W	990K Ω	$\pm 0.5\%$	EF1/2D 990K Ω	
3	R308	Metal film 1/2W	10.1K Ω	$\pm 0.5\%$	EF1/2D 10.1K Ω	
3	R309	Carbon film 1/4W	33 Ω	$\pm 5\%$	RD1/4PNYJ 33 Ω	
3	R310	Metal film 1/2W	1M Ω	$\pm 0.5\%$	EF1/2D 1M Ω	
3	R311	Metal film 1/2W	1K Ω	$\pm 0.5\%$	EF1/2D 1K Ω	
4	R401	Carbon film 1/4W	100 Ω	$\pm 5\%$	RD1/4PNYJ 100 Ω	
4	R402	Carbon film 1/4W	1K Ω	$\pm 5\%$	RD1/4PNYJ 1K Ω	
4	R403	Carbon film 1/4W	560K Ω	$\pm 5\%$	RD1/4PNYJ 560K Ω	
4	R404	Metal film 1/2W	1M Ω	$\pm 0.5\%$	EF1/2D 1M Ω	
4	R405	Carbon film 1/2W	3.3M Ω	$\pm 10\%$	RD1/2PSZK 3.3M Ω	
4	R406	Carbon film 1/4W	22 Ω	$\pm 5\%$	RD1/4PNYJ 22 Ω	
4	R407	Carbon film 1/4W	12K Ω	$\pm 5\%$	RD1/4PNYJ 12K Ω	
4	R408	Carbon film 1/4W	4.7K Ω	$\pm 5\%$	RD1/4PNYJ 4.7K Ω	
4	R409	Carbon film 1/4W	4.7K Ω	$\pm 10\%$	RD1/4PNYJ 4.7K Ω	
4	R410	Carbon film 1/4W	4.7K Ω	$\pm 5\%$	RD1/4PNYJ 4.7K Ω	
4	R411	Carbon film 1/4W	4.7K Ω	$\pm 5\%$	RD1/4PNYJ 4.7K Ω	
4	R412	Carbon film 1/4W	15K Ω	5%	PD1/4PNYJ 15K Ω	
4	R413	Carbon film 1/4W	15K Ω	$\pm 5\%$	RD1/4PNYJ 15K Ω	
4	R414	Carbon film 1/4W	680 Ω	$\pm 5\%$	RD1/4PNYJ 680 Ω	
4	R415	Carbon film 1/4W	820 Ω	$\pm 5\%$	RD1/4PNYJ 820 Ω	
4	R416	Carbon film 1/4W	820 Ω	$\pm 5\%$	RD1/4PNYJ 820 Ω	
4	R417	Carbon film 1/4W	15K Ω	$\pm 5\%$	RD1/4PNYT 15K Ω	
4	R418	Carbon film 1/4W	15K Ω	$\pm 5\%$	RD1/4PNYJ 15K Ω	
4	R419	Carbon film 1/4W	220 Ω	$\pm 5\%$	RD1/4PNYJ 220 Ω	
4	R420	Carbon film 1/4W	10K Ω	$\pm 5\%$	RD1/4PNYJ 10K Ω	
4	R421	Carbon film 1/4W	10K Ω	$\pm 5\%$	RD1/4PNYJ 10K Ω	
4	R422	Carbon film 1/4W	220 Ω	$\pm 5\%$	RD1/2PNYJ 220 Ω	
4	R423	Carbon film 1/4W	220 Ω	$\pm 5\%$	RD1/4PNYJ 220 Ω	
4	R424	Carbon film 1/4W	15K Ω	$\pm 5\%$	RD1/4PNYJ 15K Ω	
4	R425	Carbon film 1/4W	15K Ω	$\pm 5\%$	RD1/4PNYJ 15K Ω	
4	R426	Carbon film 1/4W	15K Ω	$\pm 5\%$	RD1/4PNYJ 15K Ω	
4	R427	Carbon film 1/4W	22 Ω	$\pm 5\%$	RD1/4PNYJ 22 Ω	
4	R428	Carbon film 1/4W	4.7K Ω	$\pm 5\%$	RD1/4PNYJ 4.7K Ω	
4	R429	Carbon film 1/4W	1.5K Ω	$\pm 5\%$	RD1/4PNYJ 1.5K Ω	
4	R430	Carbon film 1/4W	1.5K Ω	$\pm 5\%$	RD1/4PNYJ 1.5K Ω	
4	R431	Carbon film 1/4W	4.7K Ω	$\pm 5\%$	RD1/4PNYJ 4.7K Ω	
4	R432	Carbon film 1/4W	3.9K Ω	$\pm 5\%$	RD1/4PNYJ 3.9K Ω	
4	R433	Carbon film 1/4W	2.7K Ω	$\pm 5\%$	RD1/4PNYJ 2.7K Ω	Factory Adj.
4	R434	Carbon film 1/4W	2.7K Ω	$\pm 5\%$	RD1/4PNYJ 2.7K Ω	Factory Adj.
4	R435	Carbon film 1/4W	3.9K Ω	$\pm 5\%$	RD1/4PNYJ 3.9K Ω	
4	R436	Carbon film 1/4W	1K Ω	$\pm 5\%$	RD1/4PNYJ 1K Ω	
4	R437	Carbon film 1/4W	2.2K Ω	$\pm 5\%$	RD1/4PNYJ 2.2K Ω	
4	R438	Carbon film 1/4W	1K Ω	$\pm 5\%$	RD1/4PNYJ 1K Ω	
4	R439	Carbon film 1/4W	1.5K Ω	$\pm 5\%$	RD1/4PNYJ 1.5K Ω	
4	R440	Carbon film 1/4W	1.5K Ω	$\pm 5\%$	RD1/4PNYJ 1.5K Ω	
4	R441	Carbon film 1/4W	100 Ω	$\pm 5\%$	RD1/4PNYJ 100 Ω	
4	R442	Carbon film 1/4W	1.2K Ω	$\pm 5\%$	RD1/4PNYJ 1.2K Ω	
4	R443	Carbon film 1/4W	3.9K Ω	$\pm 5\%$	RD1/4PNYJ 3.9K Ω	
4	R444	Carbon film 1/4W	1.2K Ω	$\pm 5\%$	RD1/4PNYJ 1.2K Ω	
4	R445	Carbon film 1/4W	100	$\pm 5\%$	RD1/4PNYJ 100 Ω	
4	R446	Carbon film 1/4W	1K Ω	$\pm 5\%$	RD1/4PNYJ 1K Ω	
4	R447	Carbon film 1/4W	47 Ω	$\pm 5\%$	RD1/4PNYJ 47 Ω	
4	R448	Carbon film 1/4W	10K Ω	$\pm 5\%$	RD1/4PNYJ 10K Ω	
4	R449	Carbon film 1/4W	15K Ω	$\pm 5\%$	RD1/4PNYJ 15K Ω	
4	R450	Carbon film 1/4W	100 Ω	$\pm 5\%$	RD1/4PNYJ 100 Ω	
4	R451	Carbon film 1/4W	100 Ω	$\pm 5\%$	RD1/4PNYJ 100 Ω	
4	R452	Carbon film 1/4W	150 Ω	$\pm 5\%$	RD1/4PNYJ 150 Ω	
4	R453	Metal film 2W	1K Ω	$\pm 10\%$	MOR2XPK 1K Ω	

SCH. No.	Symbol No.	Description	RESISTORS		LEADER Parts No.	Note
4	R454	Carbon film 1/4W	150Ω	±5%	RD1/4PNYJ 150Ω	
4	R455	Carbon film 1/4W	100Ω	±5%	RD1/4PNYJ 100Ω	
4	R456	Carbon film 1/4W	100Ω	±5%	RD1/4PNYJ 100Ω	
4	R457	Metal film 7W	4.7KΩ	±10%	MOR7SPK 4.7KΩ	
4	R458	Metal film 7W	4.7KΩ	±10%	MOR7SPK 4.7KΩ	
4	R459	Carbon film 1/4W	68Ω	±5%	RD1/4PNYJ 68Ω	
6	R601	Carbon film 1/4W	100Ω	±5%	RD1/4PNYJ 100Ω	
6	R602	Carbon film 1/4W	100Ω	±5%	RD1/4PNYJ 100Ω	
6	R603	Carbon film 1/4W	56Ω	±5%	RD1/4PNYJ 56Ω	
6	R604	Carbon film 1/4W	50Ω	±5%	RD1/4PNYJ 56Ω	
6	R605	Carbon film 1/4W	330Ω	±5%	RD1/4PNYJ 330Ω	
6	R606	Carbon film 1/4W	560Ω	±5%	RD1/4PNYJ 560Ω	
6	R607	Carbon film 1/4W	1.2KΩ	±5%	RD1/4PNYJ 1.2KΩ	
6	R608	Carbon film 1/4W	1.2KΩ	±5%	RD1/4PNYJ 1.2KΩ	
6	R609	Carbon film 1/4W	2.2KΩ	±5%	RD1/4PNYJ 2.2KΩ	
6	R610	Carbon film 1/4W	4.7KΩ	±5%	RD1/4PNYJ 4.7KΩ	
6	R611	Carbon film 1/4W	10KΩ	±5%	RD1/4PNYJ 10KΩ	
6	R612	Carbon film 1/4W	22KΩ	±5%	RD1/4PNYJ 22KΩ	
6	R613	Carbon film 1/4W	1MΩ	±5%	RD1/4PNYJ 1MΩ	
6	R614	Carbon film 1/4W	100KΩ	±5%	RD1/4PNYJ 100KΩ	
6	R615	Carbon film 1/4W	820Ω	±5%	RD1/4PNYJ 820Ω	
6	R616	Carbon film 1/4W	2.7KΩ	±5%	RD1/4PNYJ 2.7KΩ	
6	R617	Carbon film 1/4W	12KΩ	±5%	RD1/4PNYJ 12KΩ	
6	R618	Carbon film 1/4W	4.7KΩ	±5%	RD1/4PNYJ 4.7KΩ	
6	R619	Carbon film 1/4W	5.6KΩ	±5%	RD1/4PNYJ 5.6KΩ	
6	R620	Carbon film 1/4W	100Ω	±5%	RD1/4PNYJ 100Ω	
6	R621	Carbon film 1/4W	10KΩ	±5%	RD1/4PNYJ 10KΩ	
6	R622	Carbon film 1/4W	22KΩ	±5%	RD1/4PNYJ 22KΩ	
6	R623	Carbon film 1/4W	100KΩ	±5%	RD1/4PNYJ 100KΩ	
6	R624	Carbon film 1/4W	22KΩ	±5%	RD1/4PNYJ 22KΩ	
6	R625	Carbon film 1/4W	82KΩ	±5%	RD1/4PNYJ 82KΩ	
6	R626	Carbon film 1/4W	22KΩ	±5%	RD1/4PNYJ 22KΩ	
6	R627	Carbon film 1/4W	680Ω	±5%	RD1/4PNYJ 680Ω	
6	R628	Carbon film 1/4W	22KΩ	±5%	RD1/4PNYJ 22KΩ	
6	R629	Carbon film 1/4W	22Ω	±5%	RD1/4PNYJ 22Ω	
6	R630	Carbon film 1/4W	680Ω	±5%	RD1/4PNYJ 680Ω	
6	R631	Carbon film 1/4W	4.7KΩ	±5%	RD1/4PNYJ 4.7KΩ	
6	R632	Carbon film 1/4W	220KΩ	±5%	RD1/4PNYJ 220KΩ	
6	R633	Carbon film 1/4W	1MΩ	±5%	RD1/4PNYJ 1MΩ	
6	R634	Carbon film 1/4W	220KΩ	±5%	RD1/4PNYJ 220KΩ	
6	R635	Carbon film 1/4W	6.8KΩ	±5%	RD1/4PNYJ 6.8KΩ	
6	R636	Carbon film 1/4W	100KΩ	±5%	RD1/4PNYJ 100KΩ	
6	R637	Carbon film 1/4W	4.7KΩ	±5%	RD1/4PNYJ 4.7KΩ	
6	R638	Carbon film 1/4W	560KΩ	±5%	RD1/4PNYJ 560KΩ	
6	R639	Carbon film 1/4W	18KΩ	±5%	RD1/4PNYJ 18KΩ	
6	R640	Carbon film 1/4W	3.3KΩ	±5%	RD1/4PNYJ 3.3KΩ	
6	R641	Carbon film 1/4W	10KΩ	±5%	RD1/4PNYJ 10KΩ	
6	R642	Carbon film 1/4W	47Ω	±5%	RD1/4PNYJ 47Ω	
6	R643	Carbon film 1/4W	10KΩ	±5%	RD1/4PNYJ 10KΩ	
6	R644	Carbon film 1/4W	4.7KΩ	±5%	RD1/4PNYJ 4.7KΩ	
6	R645	Carbon film 1/4W	8.2KΩ	±5%	RD1/4PNYJ 8.2KΩ	
6	R646	Carbon film 1/4W	12KΩ	±5%	RD1/4PNYJ 12KΩ	
6	R647	Carbon film 1/4W	10KΩ	±5%	RD1/4PNYJ 10KΩ	
6	R648	Carbon film 1/4W	1KΩ	±5%	RD1/4PNYJ 1KΩ	
6	R649	Carbon film 1/4W	27KΩ	±5%	RD1/4PNYJ 27KΩ	
6	R650	Carbon film 1/4W	1KΩ	±5%	RD1/4PNYJ 1KΩ	
6	R651	Carbon film 1/4W	10KΩ	±5%	RD1/4PNYJ 10KΩ	
6	R652	Carbon film 1/4W	10KΩ	±5%	RD1/4PNYJ 10KΩ	

SCH. No.	Symbol No.	Description			LEADER Parts No.	Note
RESISTORS						
6	R653	Carbon film ¼W	5.6KΩ	±5%	RD¼PNYJ	5.6KΩ
6	R654	Carbon film ¼W	10KΩ	±5%	RD¼PNYJ	10KΩ
6	R655	Carbon film ¼W	100KΩ	±5%	RD¼PNYJ	100KΩ
6	R656	Carbon film ¼W	1KΩ	±5%	RD¼PNYJ	1KΩ
6	R657	Carbon film ¼W	1.5KΩ	±5%	RD¼PNYJ	1.5KΩ
6	R658	Carbon film ¼W	3.9KΩ	±5%	RD¼PNYJ	3.9KΩ
6	R659	Carbon film ¼W	100KΩ	±5%	RD¼PNYJ	100KΩ
6	R660	Carbon film ¼W	47KΩ	±5%	RD¼PNYJ	47KΩ
7	R701	Carbon film ¼W	22KΩ	±5%	RD¼PNYJ	22KΩ
7	R702	Carbon film ¼W	2.4MΩ	±1%	RDIPXF	2.4MΩ
7	R703	Carbon film 1W	2.4MΩ	±1%	RDIPXF	2.4MΩ
7	R704	Carbon film 1W	1.2MΩ	±1%	RDIPXF	1.2MΩ
7	R705	Carbon film 1W	1.2MΩ	±1%	RDIPXF	1.2MΩ
7	R706	Carbon film ½W	600KΩ	±1%	RD¼PXF	600KΩ
7	R707	Carbon film 1W	2.4MΩ	±1%	RDIPXF	2.4MΩ
7	R708	Carbon film 1W	1.2MΩ	±1%	RDIPXF	1.2MΩ
7	R709	Carbon film ¼W	18KΩ	±5%	RD¼PNIJ	18KΩ
7	R710	Carbon film ¼W	56KΩ	±5%	RD¼PNYJ	56KΩ
7	R711	Carbon film ¼W	18KΩ	±5%	RD¼PNYJ	18KΩ
7	R712	Carbon film ¼W	33KΩ	±5%	RD¼PNYJ	33KΩ
8	R801	Carbon film ½W	1MΩ	±10%	RD½PSZK	1MΩ
8	R802	Carbon film ¼W	10KΩ	±5%	RD¼PNYJ	10KΩ
8	R803	Carbon film ¼W	560KΩ	±5%	RD¼PNYJ	560KΩ
8	R804	Carbon film ¼W	1KΩ	±5%	RD¼PNYJ	1KΩ
8	R805	Carbon film ¼W	100Ω	±5%	RD¼ PNYJ	100Ω
8	R806	Carbon film ¼W	220Ω	±5%	RD¼PNYJ	220Ω
8	R807	Carbon film ¼W	150	±5%	RD¼PNYJ	150KΩ
8	R808	Carbon film ¼W	12K	±5%	RD¼PNYJ	12KΩ
8	R809	Carbon film ¼W	22K	±5%	RD¼PNYJ	22KΩ
8	R810	Carbon film ¼W	150K	±5%	RD¼PNYJ	150KΩ
8	R811	Carbon film ¼W	22KΩ	±5%	RD¼PNYJ	22KΩ
8	R812	Carbon film ¼W	33K	±5%	RD¼PNYJ	33KΩ
8	R813	Carbon film ¼W	18K	±5%	RD¼PNYJ	18KΩ
8	R814	Carbon film ½W	390KΩ	±5%	RD¼PNYJ	390KΩ
8	R815	Carbon film ¼W	1KΩ	±5%	RD¼PNYJ	1KΩ
8	R816	Carbon film ¼W	39KΩ	±5%	RD¼PNYJ	39KΩ
8	R817	Carbon film ½W	68KΩ	±10%	RD½PSZK	68KΩ
8	R818	Carbon film ½W	68KΩ	±10%	RD½PSZK	68KΩ
8	R819	Metal film 5W	22KΩ	±10%	MOS5SPK	22KΩ
8	R820	Carbon film ½W	390KΩ	±10%	RD½ PSZK	390KΩ
8	R821	Carbon film ¼W	39KΩ	±5%	RD¼PNYJ	39KΩ
8	R822	Carbon film ½W	39KΩ	±10%	RD¼ PNYJ	39KΩ
8	R823	Carbon film ½W	390KΩ	±10%	RD½ PSZK	390KΩ
8	R824	Carbon film ¼W	1KΩ	±5%	RD¼ PNYJ	1KΩ
8	R825	Carbon film ¼W	39KΩ	±5%	RD¼PNYJ	39KΩ
8	R826	Carbon film ¼W	39KΩ	±5%	RD¼PNYJ	39KΩ
8	R827	Carbon film ½W	68KΩ	±10%	RD½PSZK	68KΩ
8	R828	Carbon film ½W	68KΩ	±10%	RD½PSZK	68KΩ
8	R829	Metal film 5W	22KΩ	±10%	MOR5SPK	22KΩ
8	R830	Carbon film ¼W	2.2KΩ	±5%	RD¼ PNJ	2.2KΩ
8	R831	Carbonfilm ¼W	22KΩ	±5%	RD¼PNYJ	22KΩ
8	R832	Carbon film ¼W	47KΩ	±5%	RD¼PNYJ	4.7KΩ
9	R901	Carbon film ¼W	100Ω	±5%	RD¼PNYJ	100Ω
9	R902	Carbon film ¼W	100Ω	±5%	RD¼PNYJ	100Ω
9	R903	Carbon film ¼W	8.2KΩ	±5%	RD¼PNYJ	8.2KΩ
9	R904	Carbon film ¼W	8.2KΩ	±5%	RD¼PMYJ	8.2KΩ
9	R905	Carbon film ¼W	12Ω	±5%	RD¼PNYJ	12Ω
9	R906	Carbon film ¼W	12Ω	±5%	RD¼PNYJ	12Ω
9	R907	Carbon film ¼W	8.2KΩ	±5%	RD¼PNYJ	8.2KΩ
9	R908	Carbon film ¼W	82KΩ	±5%	RD¼PNYJ	82KΩ

SCH. No.	Symbol No.	Description	LEADER Parts No.	Note
9	R909	Carbon film ¼W	56KΩ ±5%	RD¼PNYJ 56KΩ
9	R910	Carbon film ¼W	22KΩ ±5%	RD¼PNYJ 22KΩ
9	R911	Carbon film ¼W	2.2MΩ ±5%	RD¼PNYJ 2.2MΩ
9	R912	Carbon film ¼W	1KΩ ±5%	RD¼PNYJ 1KΩ
9	R913	Carbon film ¼W	470KΩ ±5%	RD¼YNYJ 470KΩ
9	R914	Carbon film ¼W	15KΩ ±5%	RD¼PNYJ 15KΩ
9	R915	Carbon film ¼W	10KΩ ±5%	RD¼PNYJ 10KΩ
9	R916	Carbon film ¼W	10KΩ ±5%	RD¼PNYJ 10KΩ
9	R917	Carbon film ¼W	4.7KΩ ±5%	RD¼PNYJ 4.7KΩ
9	R918	Carbon film ¼W	10KΩ ±5%	RD¼PNYJ 10KΩ
9	R919	Carbon film ¼W	10KΩ ±5%	RD¼PNYJ 10KΩ
9	R920	Carbon film ¼W	4.7KΩ ±5%	RD¼PNYJ 4.7KΩ
9	R921	Carbon film ¼W	4.7KΩ ±5%	RD¼PNYJ 4.7KΩ
9	R922	Carbon film ¼W	100KΩ ±5%	RD¼PNYJ 100KΩ
9	R923	Carbon film ¼W	100KΩ ±5%	RD¼PNYJ 100KΩ
9	R924	Carbon film ¼W	10KΩ ±5%	RD¼PNYJ 10KΩ
9	R925	Carbon film ¼W	8.2KΩ ±5%	RD¼PNYJ 8.2KΩ
9	R926	Carbon film ¼W	82KΩ ±5%	RD¼PNYJ 82KΩ
9	R927	Carbon film ¼W	4.7KΩ ±5%	RD¼PNYJ 4.7KΩ
9	R928	Carbon film ¼W	5.6KΩ ±5%	RD¼PNYJ 5.6KΩ
9	R929	Carbon film ¼W	330Ω ±5%	RD¼PNYJ 330Ω

VARIABLE RESISTORS

1	VR102	Solid 0.15W	1KΩ ±25%	SR19R-B 1KΩ	⊙ +27V
1	VR103	Solid 0.15W	1KΩ ±25%	SR19R-B 1KΩ	⊙ -27V
1	VR101	W.W ½W	50Ω ±10%	RA16YN15SB50ΩK	SCALE ILLUM
2	VR205	Solid 0.3W	100KΩ ±25%	SM19R-B 100KΩ	⊙ ASTIG
2	VR204	Carbon film 0.25W	1MΩ ±20%	V24L5 (8x10)N20SB1MΩ	FOCUS
2	VR203	Solid 0.15W	10KΩ ±25%	SR19R-B10KΩ	⊙ INTEN
2	VR206	Carbon film 0.5W	10KΩ ±20%	V24L5GN (8x10)	INTEN.
2	VR207	Carbon film 0.5W	100KΩ ±20%	20SB 10K/100K	⊙ GATE CURR
4	VR401	Solid 0.15W	470Ω ±25%	SR19R-B 470KΩ	⊙ FET BIAS FINE
4	VR402	Solid 0.15W	4.7KΩ ±25%	SR19R-B 4.7KΩ	⊙ FET BIAS COARSE
4	VR403	Solid 0.15W	100KΩ ±25%	SR19R-B 100KΩ	⊙ DC BAL
4	VR404	Solid 0.15W	3.3KΩ ±25%	SR19R-B 3.3KΩ	⊙ GAIN Gang with VR407
4	VR405	Carbon film 0.1W	300Ω ±20%	DM10A15R-B 10KΩ/B300Ω	VARIABLE with S401 and S103 (F.C.W. lock)
4	VR406	Carbon film 0.5W	300Ω ±20%	V24L5 S2 (DF) 15SC300Ω	↕ Gang with VR405 not assigned
4	VR407	Carbon film 0.5W	10KΩ ±20%	DM10A15R-B10KΩ/B300Ω	⊙ MF
4	VR408	Carbon film 0.5W	10KΩ ±20%	DM10A15R-B10KΩ/B300Ω	⊙ ± BAL
4	VR409	Solid 0.15W	2.2KΩ ±25%	SR19R-B 2.2KΩ	⊙ LEVEL CENTER
6	VR601	Solid 0.15W	330Ω ±25%	SR19R-B330Ω	TRIG. LEVEL with S602
6	VR602	Solid 0.15W	4.7KΩ ±25%	SR19R-B 4.7KΩ	⊙ AUTO BAL
6	VR603	Carbon film	5KΩ		⊙ TV. BIAS
6	VR604	Solid 0.15W	1MΩ ±25%	SR19R-B 1MΩ	⊙ STAB
6	VR605	Solid 0.15W	100KΩ ±25%	SR19R-B 100KΩ	VARIABLE Gang with VR803
6	VR606	Solid 0.15W	3.3KΩ ±25%	SR19R-B 3.3KΩ	⊙ LENGTH
6	VR607	Carbon film 0.5W	10KΩ ±20%		⊙ TV-V
6	VR608	Solid 0.15W	2.2KΩ ±25%	SR19R-B 2.2KΩ	⊙ TV-H
7	VR701	Solid 0.15W	33KΩ ±25%	SR19R-B 33KΩ	⊙ DC BAL
7	VR702	Solid 0.15W	33KΩ ±25%	SR19R-B 33KΩ	⊙ WIDTH
8	VR802	Solid 0.15W	33KΩ ±25%	SR19R-B 33KΩ	VARIABLE Gang with VR607
8	VR803	Solid 0.15W	33KΩ ±25%	SR19R-B 33KΩ	↔ with S801
8	VR804	Carbon film 0.5W	100KΩ ±20%		⊙ MAG x 5
8	VR805	Carbon film 0.5W	50KΩ ±20%		⊙ MAG CENTER
8	VR807	Solid 0.15W	10KΩ ±25%	SR19R-B 10KΩ	⊙ CAL
8	VR808	Solid 0.15W	10KΩ ±25%	SR19R-B 10KΩ	
9	VR901	Solid 0.15W	470Ω ±25%	SR19R-B 470Ω	

SCH. No.	Symbol No.	Description	LEADER Parts No.	Note
CAPACITORS				
1	C101	Electrolytic 150V	47 μ F	160T47
1	C102	Electrolytic 470V	22 μ F	470T22
1	C103	Electrolytic 300V	47 μ F	315T47
1	C104	Electrolytic 300V	47 μ F	317T47
1	C105	Electrolytic 80V	1000 μ F	ECE-M80R1000E
1	C106	Electrolytic 50V	22 μ F	50VBSN22
1	C107	Plastic film 50V	0.1 μ F \pm 10%	CQ92MBIH104K
1	C108	Plastic film 50V	0.01 μ F \pm 10%	CQ92MHIH103K
1	C109	Electrolytic 50V	1 μ F	50VBSN1
1	C110	Plastic film 50V	0.1 μ F	CQ92MBIH104K
1	C111	Electrolytic 80V	1000 μ F ECE-	ECE-M80R1000E
1	C112	Electrolytic 100V	47 μ F	CE02D2A470
1	C113	Electrolytic 50V	22 μ F	50VBSN22
1	C114	Plastic film 50V	0.1 μ F \pm 10%	CQ92MBIH104K
1	C115	Electrolytic 50V	1 μ F	50VBSN1
1	C116	Plastic film 50V	0.1 μ F \pm 10%	CQ92HBIH 104K
1	C117	Electrolytic 16V	470 μ F	16T470
1	C118	Electrolytic 16V	470 μ F	16T470
2	C201	Plastic film 400V	0.01 μ F \pm 20%	MD22G103M
2	C202	Oil 3KV	0.022 μ F \pm 20%	ECN-D30223M
2	C203	Ceramic 3KV	470pF	DD6200YW470pF
2	C204	Plastic film 50V	1000pF	CQ92MBIH102K
2	C205	Plastic film 250V	0.1 μ F \pm 20%	MD22E104M
2	C206	Plastic film 50V	470pF \pm 10%	CQ08SC1H471H
2	C216	Mica 500V	10pH \pm 10%	FM05ZC100K
2	C217	Oil 400V	0.01 μ F \pm 20%	CP021E2G103M
2	C218	Oil 400V	0.01 μ F \pm 20%	CP021E2G103M
2	C219	Electrolytic 500V	4.7 μ F	500T 4.7
2	C220	Electrolytic 500V	4.7 μ F	500T4.7
2	C221	Electrolytic 500V	4.7 μ F	500T4.7
2	C222	Electrolytic 500V	4.7 μ F	500T4.7
2	C223	Electrolytic 500V	4.7 μ F	500T4.7
2	C224	Electrolytic 500V	4.7 μ F	500T4.7
2	C225	Oil 1.5KV	0.5 μ F	K150DCLU504M
2	C226	Oil 1.5KV	0.5 μ F	K150DCLU504M
2	C227	Oil 1.5KV	0.5 μ F	K150DCLU504M
2	C228	Oil 1.5KV	0.5 μ F	K150DCLU504M
3	C301	Plastic film 630V	0.1 μ F \pm 10%	6MFT-D104K
3	C302	Mica 500V	18pF \pm 10%	FM06ZC180K
3	C303	Mica 500V	5pF \pm 10%	FM05ZC050K
3	C304	Mica 500V	33pF \pm 100%	FM07ZC330K
3	C305	Mica 500V	120pF \pm 10%	FM10ZC121K
3	C306	Plastic film 50V	1500 μ F \pm 10%	CQ92MB1H152K
3	C307	Plastic film 50V	0.01 μ F \pm 10%	CQ92MBIH103K
4	C401	Plastic film 50V	0.01 μ F \pm 10%	CQ92MB1H103K
4	C402	Plastic film 630V	0.01 μ F \pm 20%	MD22J103M
4	C403	Ceramic 50V	1000pF	RD204YM102
4	C404	Ceramic 50V	1000pF	RD204YM102
4	C405	Ceramic 50V	0.01 μ F	RD204YM103
4	C406	Mica 500V	10pF \pm 10%	FM05ZC100K
4	C407	Ceramic 50V	0.01 μ F	RD204YM103
4	C408	Electrolytic 50V	4.7 μ F	50VBSN4R7
4	C409	Ceramic 50V	0.01 μ F	RD204YM103
4	C410	Mica 500V	18pF \pm 10%	FM06ZC180K
4	C411	Ceramic 50V	0.01 μ F	RD204YM103
4	C412	Electrolytic 50V	4.7 μ F	50VBSN4R7
4	C413	Mica 500V	27pF \pm 10%	FM07ZC270K
4	C414	Mica 500V	56pF \pm 10%	FM08ZC560K

SCH. No.	Symbol No.	Description			LEADER Parts No.	Note
4	C415	Cermic	50V	0.01 μ F	RD204YM103	
4	C416	Cermic	50V	0.01 μ F	RD204YM103	
4	C417	Electrolytic	50V	1 μ F	50VBSN1	
6	C601	Mica	500V	10pF	FM05ZC100K	
6	C602	Mica	500V	220pF	V-FM08ZC221K	
6	C603	Electrolytic	50V	3.3pF	50VBSN3R3	
6	C604	Ceramic	50V	0.05pF	RD209YM503Z50	
6	C605	Plastic film	100V	0.47 μ F	IMFT-D474	
6	C606					not assigned
6	C607	Mica	500V	3pF	FM05ZCO30K	
6	C608					not assigned
6	C609	Mica	500V	47pF	FM08ZC470K	
6	C610	Mica	500V	27pF	FM07ZC270K	
6	C611	Mica	500V	22pF	FM06ZC220K	
6	C612	Plastic film	100V	0.47 μ F	IMET-D474	
6	C613	Mico	500V	5pF	FM05ZC50K	
6	C614	Mica	500V	15pF	FM05ZC150K	
6	C615	Mica	500V	10pF	FM05ZC100K	
6	C616	Ceramic	50V	0.01 μ F	RD209YM103	
6	C617	Mica	50V	100pF	V-FM06ZC101K	
6	C618					not assigned
6	C619	Mica	50V	100pF	V-FM06ZC101K	
6	C620	Mica	50V	220pF	V-FM08ZC221K	
7	C701	Electrolytic	50V	1 μ F	50 VBSN1	
7	C702	Plastic film	50V	0.1 μ F	CQ92MB1H104K	
7	C703	Plastic film	50V	0.01 μ F	CQ92MB1H103K	
7	C704	Plastic film	50V	1000pF	CQ92MB1H102K	
7	C705	Mica	500V	68pF	FM082ZC680K	
7	C706	Plastic film	100V	1 μ F	CQ-14T2A105G	
7	C707	Plastic film	100V	0.1 μ F	TNX104G 100V	
7	C708	Plastic film	100V	0.01 μ F	TNX103G 100V	
7	C709	Plastic film	125V	1000pF	CQ08P2B102G	
7	C710	Mica	500V	82pF	FM09ZC820K	
7	C711	Mica	500V	33pF	FM07ZC330K	
8	C801	Plastic film	630V	0.1 μ F	6MFT-D104K	
8	C802	Mica	500V	220pF	FM12ZC221K	
8	C803	Ceramic	50V	1000pF	RD204YM102	
8	C804	Plastic film	50V	680pF	CQ08SCH1H681K	
8	C805	Plastic	500V	1pF	ECG-N5010K	
8	C806	Plastic	500V	1pF	ECG-N5010K	
8	C807	Plastic	500V	1pF	ECG-N5010K	
8	C808	Plastic	500V	1pF	ECG-N5010K	
8	C809	Plastic	500V	1pF	ECG-N5010K	
8	C810	Plastic	500V	1pF	ECG-N5010K	
8	C811	Ceramic	50V	0.01 μ F	RD204YM103	
9	C901	Electrolytic	50V	1 μ F	50VBSN1	
9	C902	Plastic film	100V	0.47 μ F	IMFT-D474	
9	C903	Electrolytic	50V	1 μ F	50VBSN1	
9	C904	Plastic film	50V	0.047 μ F	CQ92MB1H473K	
9	C905	Plastic film	50V	1000pF	CQ92MB1H102K	
9	C906	Plastic film	50V	1000pF	CQ92MB1H102K	
9	C907	Plastic film	50V	1000pF	CQ92MB1H102K	
9	C908	Plastic film	50V	0.047 μ F	CQ92MB1H473K	
9	C909	Plastic film	50V	0.047 μ F	CQ92MB1H473K	
9	C910	Electrolytic	16V	47 μ F	16VBSN47	
9	C911	Plastic film	50V	6800pF	CQ92MB1H682K	
9	C912	Plastic film	50V	6800pF	CQ92MB1H682K	
9	C913	Mica	500V	27pF	FM07ZC270K	

SCH. No.	Symbol No.	Description	LEADER Parts No.	Note
VARIABLE CAPACITORS				
3	VC301	Ceramic 500V 20pF	ECV-1ZW20P32	∅ Vertical Attenuator
3	VC302	Ceramic 500V 20pF	ECV-1ZW20P32	∅ Vertical Attenuator
3	VC303	Ceramic 500V 20pF	ECV-1ZW20P32	∅ Vertical Attenuator
3	VC304	Ceramic 500V 20pF	ECV-1ZW20P32	∅ Vertical Attenuator
3	VC305	Ceramic 500V 20pF	ECV-1ZW20P32	∅ Vertical Attenuator
3	VC306	Ceramic 500V 20pF	ECV-1ZW20P32	∅ Vertical Attenuator
3	VC307	Ceramic 500V 20pF	ECV-1ZW20P32	∅ Vertical Attenuator
3	VC308	Ceramic 500V 20pF	ECV-1ZW20P32	∅ Vertical Attenuator
3	VC309	Ceramic 500V 20pF	ECV-1ZW20P32	∅ Vertical Attenuator
3	VC310	Ceramic 500V 20pF	ECV-1ZW20P32	∅ Vertical Attenuator
4	VC401	Ceramic 500V 20pF	ECV-1ZW20P32	∅ Vertical Attenuator
4	VC402	Ceramic 500V 50pF	ECV-1ZW50P32	∅ HF
7	VC701	Ceramic 500V 20pF	ATSWECV20pF	∅ Time BASE
7	VC702	Ceramic 500V 20pF	ATSWECV20pF	∅ Time Bdse
TUBES				
2	V201	CRT	130ARB1/B7	
2	V202	NEON 68V	NE-2	
2	V203	NEON 68V	NE-2	
2	V204	NEON 68V	NE-2	
2	V205	NEON 68V	NE-2	
TRANSISTORS				
1	Q101	NPN $V_{ce0} = 40V, P_t = 15W$	2SD150	or 2SD315, 2SC1160
1	Q102	NPN $V_{ce0} = 100V$	2SC499-Y	
1	Q103	NPN $V_{ce0} = 100V$	2SC499-Y	
1	Q104	NPN $V_{ce0} = 40V, P_t = 1.5W$	2SD150	or 2SD315, SSC1160
1	Q105	PNP $V_{ce0} = 50V$	2SA678-6	
1	Q106	PNP $V_{ce0} = 50V$	2SA678-6	
2	Q201	NPN $V_{cbo} = 300V$	2SC515A	or 2SC685A.
2	Q202	NPN $V_{cbo} = 250V, P_c = 2.5W (T_c = 125^\circ C)$	2SC1012A	
2	Q203	NPN $V_{cbo} = 250V, P_c = 2.5W (T_c = 125^\circ C)$	2SC1012A	
4	Q401	NPN $V_{ce0} = 30V$	2SC458-B	or 2SC459-C
4	Q402	NPN $V_{ce0} = 30V$	2SC458-B	or 2SC458-C
4	Q403	J-FET $V_{dgo} = 30V, I_{DSS} = 2.5 \sim 6mA$	2SK34-D	Selected Pair IDSS 10%
4	Q404	J-FET $V_{dgo} = 30V, I_{DSS} = 2.5 \sim 6mA$	2SK34-D	
4	Q405	NPN $V_{ce0} = 30V$	2SC458-B	or 2SC458-C
4	Q406	NPN $V_{ce0} = 30V$	2SC458-B	or 2SC458-C
4	Q407	NPN $V_{ce0} = 30V$	2SC458-B	or 2SC458-C
4	Q408	NPN $V_{ce0} = 30V$	2SC458-B	or 2SC458-C
4	Q409	NPN $V_{ce0} = 30V$	SSC458-B	or 2SC458-C
4	Q410	NPN $V_{ce0} = 30V$	2SC458-B	or 2SC458-C
4	Q411	NPN $V_{ce0} = 30V$	2SC458-B	or 2SC458-C
4	Q412	PNP $V_{ce0} = 50V$	2SC678-6	
4	Q413	PNP $V_{ce0} = 50V$	2SA678-6	
4	Q414	NPN $V_{ce0} = 30V$	2SC458-B	or 2SC458-C
4	Q415	NPN $V_{ce0} = 30V$	2SC458-B	or 2SC458-C
4	Q416	NPN $V_{cbo} = 40V, P_c = 500mW$	2SC423-D	
4	Q417	NPN $V_{cbo} = 250V, P_c = 2.5W (T_c = 125^\circ C)$	2SC1012A	
4	Q418	NPN $V_{cbo} = 40V, P_c = 500mW$	2SC423-D	
4	Q419	NPN $V_{cbo} = 250V, P_c = 2.5W (T_c = 125^\circ C)$	2SC1012A	
4	Q420	NPN $V_{ce0} = 35V, P_c = 1.5W$	2SD235-0	
6	Q601	NPN $V_{cbo} = 30V$	2SC645	
6	Q602	NPN $V_{cbo} = 30V$	2SC645	
6	Q603	NPN $V_{cbo} = 30V$	2SC645	

SCH. No.	Symbol No.	Description	LEADER Parts No.	Note
6	Q604	NPN Vcbo=30V	2SC645	
6	Q605	NPN Vcbo=30V	2SC645	
6	Q606	NPN Vcbo=30V	2SC645	
6	Q607	NPN Vcbo=30V	2SC645	
6	Q608	NPN Vceo=30V	2SC458-B	or 2SC458-C
6	Q609	NPN Vceo=30V	2SC458-B	or 2SC458-C
6	Q610	PNP Vceo=50V	2SA678-6	
6	Q611	NPN Vcbo=160V	2SC869	
6	Q612	NPN Vceo=30V	2SC458-B	or 2SC458-C
6	Q613	NPN Vceo=30V	2SC458-B	or 2SC458-C
6	Q614	NPN Vceo=30V	2SC458-B	or 2SC458-C
6	Q615	J-FET Vdgo= 30V, IDSS=2.6~6mA	2SK34-D	
6	Q616	NPN Vceo=30V	2SC458-B	or 2SC458-C
6	Q617	NPN Vceo=100V	2SC499-Y	
6	Q618	NPN Vceo=30V	2SC458-B	or 2SC458-C
6	Q619	NPN Vceo=30V	2SC458-B	or 2SC458-C
8	Q801	NPN Vceo=100V	2SC499-Y	
8	Q802	NPN Vceo=100V	2SC499-Y	
8	Q803	PNP Vceo=50V	2SA678-6	
8	Q804	NPN Vceo=200V	2SC154-C	or 2SC1012A
8	Q805	NPN Vceo=200V	2SC154-C	or 2SC1012A
8	Q806	PNP Vceo=50V	2SA678-6	
8	Q807	NPN Vceo=200V	2SC154-C	or 2SC1012A
8	Q808	NPN Vceo=200V	2SC154-C	or 2SC1012A
8	Q809	NPN Vceo=30V	2SC458-B	or 2SC458-C
9	Q901	NPN Vceo=30V	2SC458-B	or 2SC458-C
9	Q902	NPN Vceo=30V	2SC458-B	or 2SC458-C
9	Q903	NPN Vcbo=160V	2SC869	
9	Q904	NPN Vceo=30V	2SC458-B	or 2SC458-B
9	Q905	NPN Vceo=30V	2SC458-B	or 2SC458-B
9	Q906	NPN Vceo=50V	2SA678-6	

DIODES

1	D101	Rect.	400V	1.1A	V06E	
1	D102	Rect.	600V	1.1A	V06G	
1	D103	Rect.	600V	1.1A	V06G	
1	D104	Rect.	200V	1.1A	V06C	
1	D105	Rect.	200V	1.1A	V06C	
1	D106	Rect.	200V	1.1A	V06C	
1	D107	Rect.	200V	1.1A	V06C	
1	D108	Zener	7V		RD7A	
1	D109	Det.	35V		1S1555	or 1S1588
1	D110	Rect.	100V	1.1A	V06B	
1	D111	Rect.	100V	1.1A	V06B	
1	D112	Rect.		1.1A	V06B	
1	D113	Rect.		1.1A	V06B	
2	D201	Rect.	100V	0.5A	1S1941	
2	D202	Zener	6V		RD6A	
2	D203	Zener	6V		RD6A	
2	D204	Det	35V		1S1555	or 1S1588
2	D206	Rect	1.5KV	0.1A	1S2355	or 1S1R150
2	D207	Rect	1.5KV	0.1A	1S2355	or 1S1R150
2	D208	Rect.	1.5KV	0.1A	1S2355	or 1S1R150
2	D209	Rect.	1.5KV	0.1A	1S2355	or 1S1R150
2	D210	Rect	1.5KV	0.1A	1S2355	or 1S1R150
2	D211	Rect.	1.5KV	0.1A	1S2355	or 1S1R150
2	D212	Rect.	1.5KV	0.1A	1S2355	or 1S1R150
2	D213	Rect.	1.5KV	0.1A	1S2355	or 1S1R150

SCH. No.	Symbol No.	Description			LEADER Parts No.	Note
4	D401	Det.	35V		1S1588	or 1S1555
4	D402	Det.	35V		1S1588	or 1S1555
4	D403	Det.	35V		1S1588	or 1S1555
4	D404	Det.	35V		1S1588	or 1S1555
4	D405	Zener	6V		RD6A	
6	D601	Rect	100V	0.5A	1S1941	
6	D602	Rect	100V	0.5A	1S1941	
6	D603	Rect	100V	0.5A	1S1941	
6	D604	Ge. Det	35V		1N60	
6	D605	Ge. Det	35V		1N60	
6	D606	Det	35V		1S1588	or 1S1555
6	D607	Det	35V		1S1588	or 1S1555
6	D608	Det	35V		1S1588	or 1S1555
6	D609	Rect	100V	0.5A	1S1941	
6	D610	Det	35V		1S1588	or 1S1555
6	D611	Det	35V		1S1588	or 1S1555
8	D801	Det	60V		1S2076A	
8	D802	Rect	100V		1S1941	
8	D803	Det	35V		1S1588	or 1S1555
9	D901	Ge. Det	35V		1N60	
9	D901	Ge. Det	35V		1N60	
9	D902	Zener	6V		RD6A	
9	D903	Det	35V		1S1588	or 1S1555
TRANSFORMERS						
1	PT102	Power Transformer			J-295 (502-J-002A),	
PRINTED CIRCUIT BOARDS						
2		HV RECT			T-666	
3		V. ATT			T-663	
4		V. AMP			T-664	
4		V. FINAL			T-588A	
6		MIAN			T-592	
1		PILOT			T-665	
1		PILOT			T-665	
2		VECTOR			T-294A	
FUSE & LAMP						
1	F101	SLOW BLOW	100~115V 1A (200~230V, 0.5A)			
1	F101	HOLDER			FH003	
1	PL101	Neon			BNB-2	Transparency
1	PL104		5V	0.115A	BQ034-22212A	
1	PL105		5V	0.115A	BQ034-22212A	
3	PL301		5V	0.115A	BQ034-22212A	
3	PL302		5V	0.115A	BQ034-2221.2A	
3	PL303		5V	0.115A	BQ034-22212A	
6	PL601	Neon			BNB-2	Transparency
SWITCHES						
1	S101	Toggle			MST-106D	Power
1	S102	Slide			S2200	
1	S103					with VR406
2	S201	Slide			S2200	
2	S202	Slide			S2200	
3	S301	Push	3 key		Q-302 (502-Q-4)	
3	S302	Push	3 key		Q-302 (502-Q-4)	
3	S303	Push	3 key		Q-302 (502-Q-4)	
3	S305	Rotary			Q-301 (502-Q-2)	
4	S401					S22/VR 3-6-11 with VR406

SCH. No.	Symbol No.	Description		LEADER Parts No.	Note
6	S601	Push	3 key	Q-303 (502-Q-5)	
6	S602				with VR603
6	S603	Push	3 key	Q-303 (502-Q-5)	
7	S701	Rotary		Q-271	S32/VR 5-11-20
7	S702	Push	3 key	Q-303 (502-Q-5)	
8	S801				with VR805
TERMINALS & CONNECTORS					
1	J101	AC RECEPTACLE		S-7070	
2	J201	Banana Jack		No. 375 (Red)	
2	J202	Banana Jack		No. 375 (Black)	
2	J203	Banana Jack		No. 375 (Red)	
2	J204	Banana Jack		No. 375 (Red)	
3	J301	BNC		BNC-BR2	
3	J302	Metal Terminal		D-1376	
8	J801	Banana Jack		No. 375 (Red)	
8	J802	Banana Jack		No. 375 (Black)	
9	J901	Banana Jack		No. 375 (Red)	

JTN

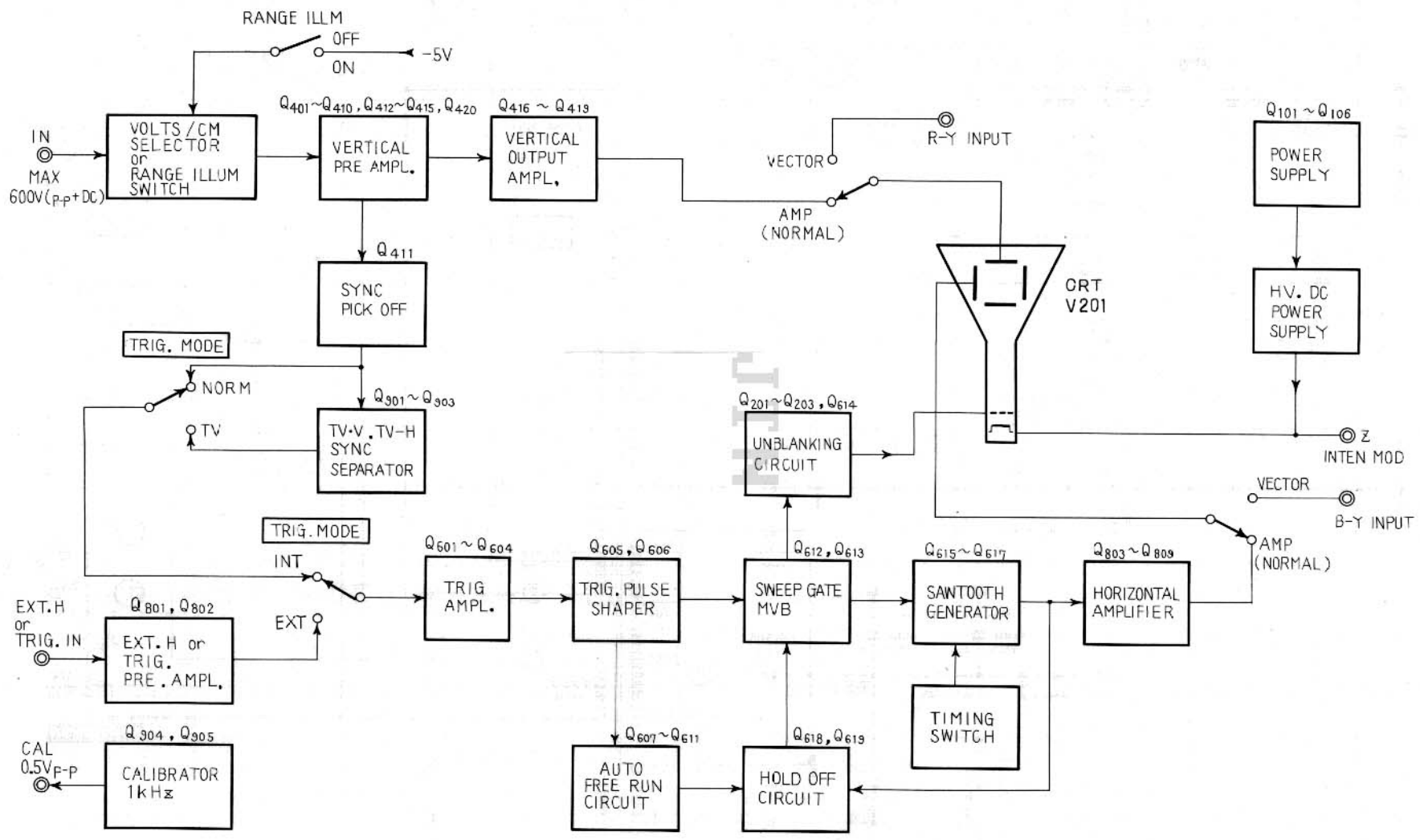

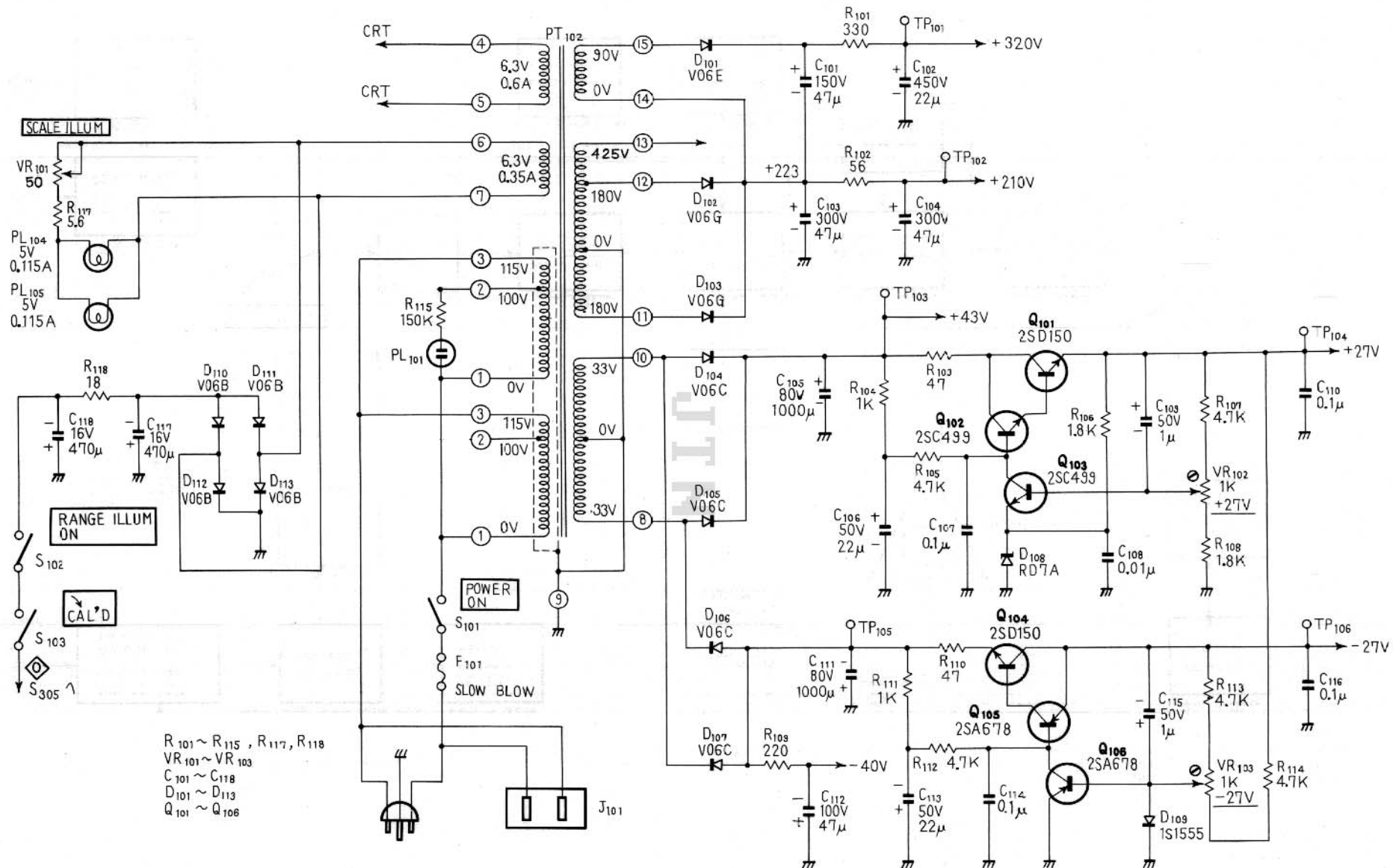

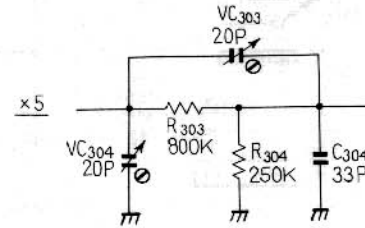
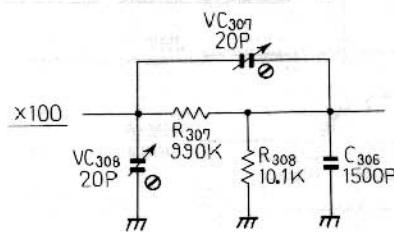
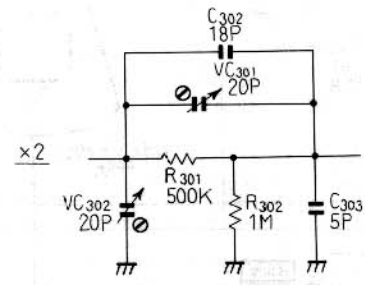
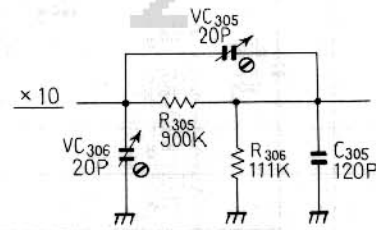
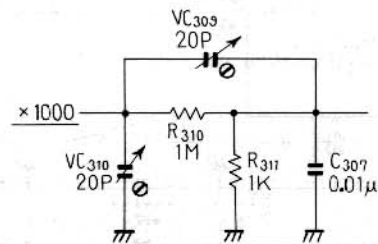
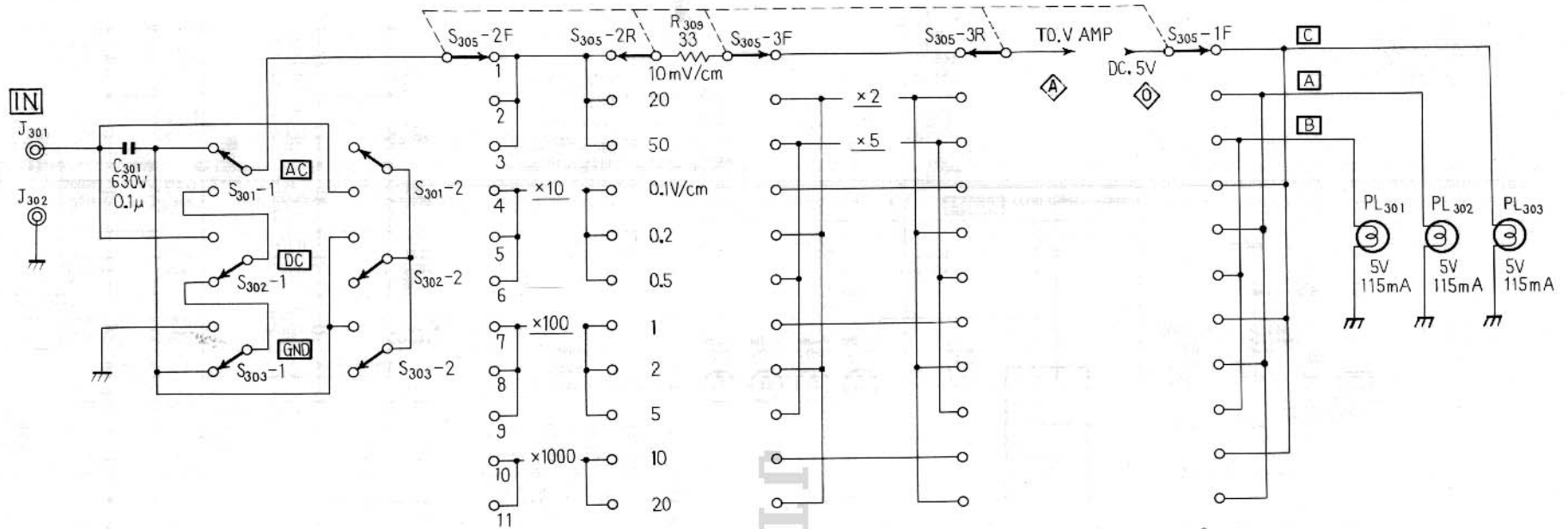

R₃₀₁ ~ R₃₁₁
 C₃₀₁ ~ C₃₀₇
 VC₃₀₁ ~ VC₃₁₀

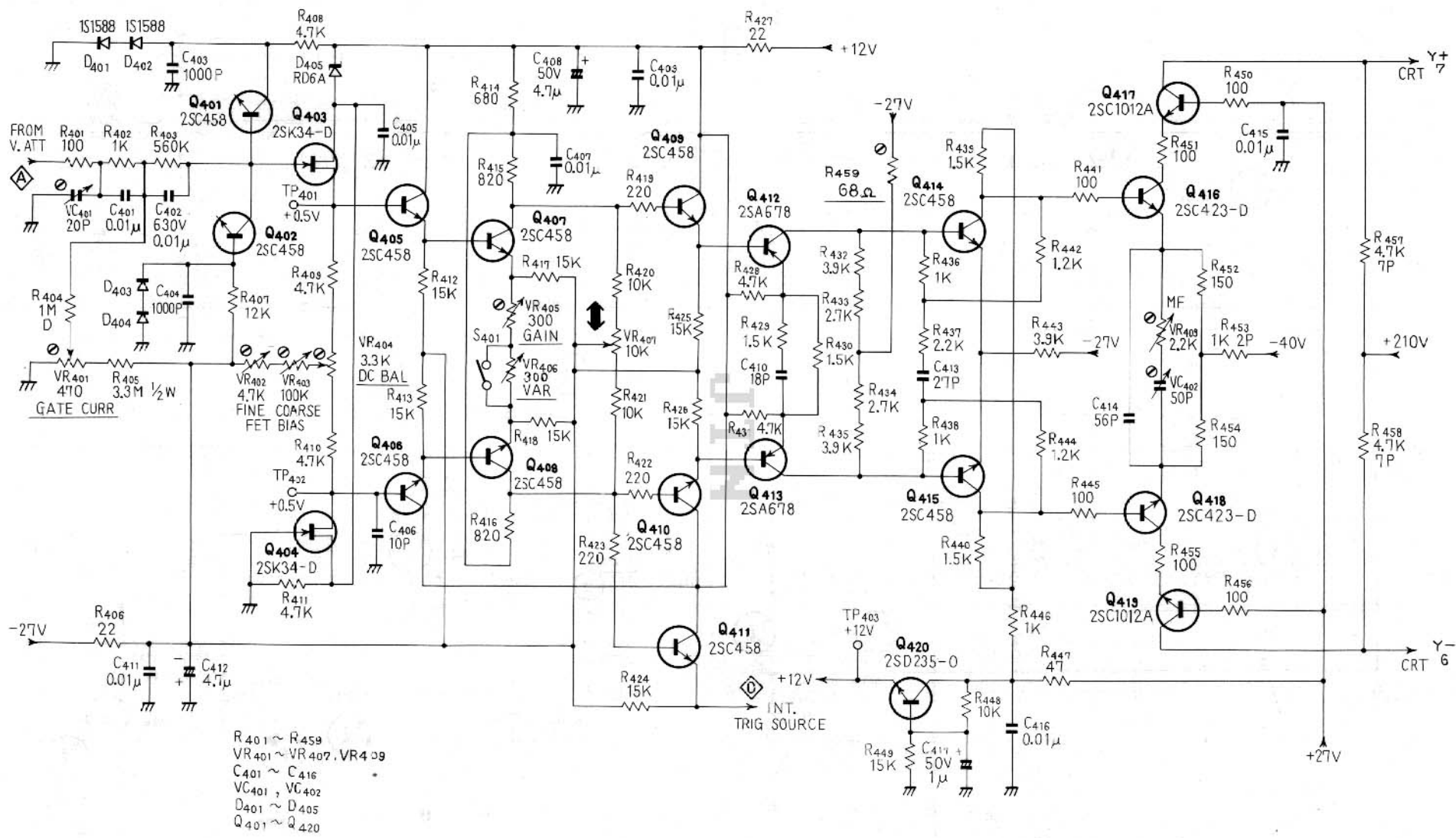

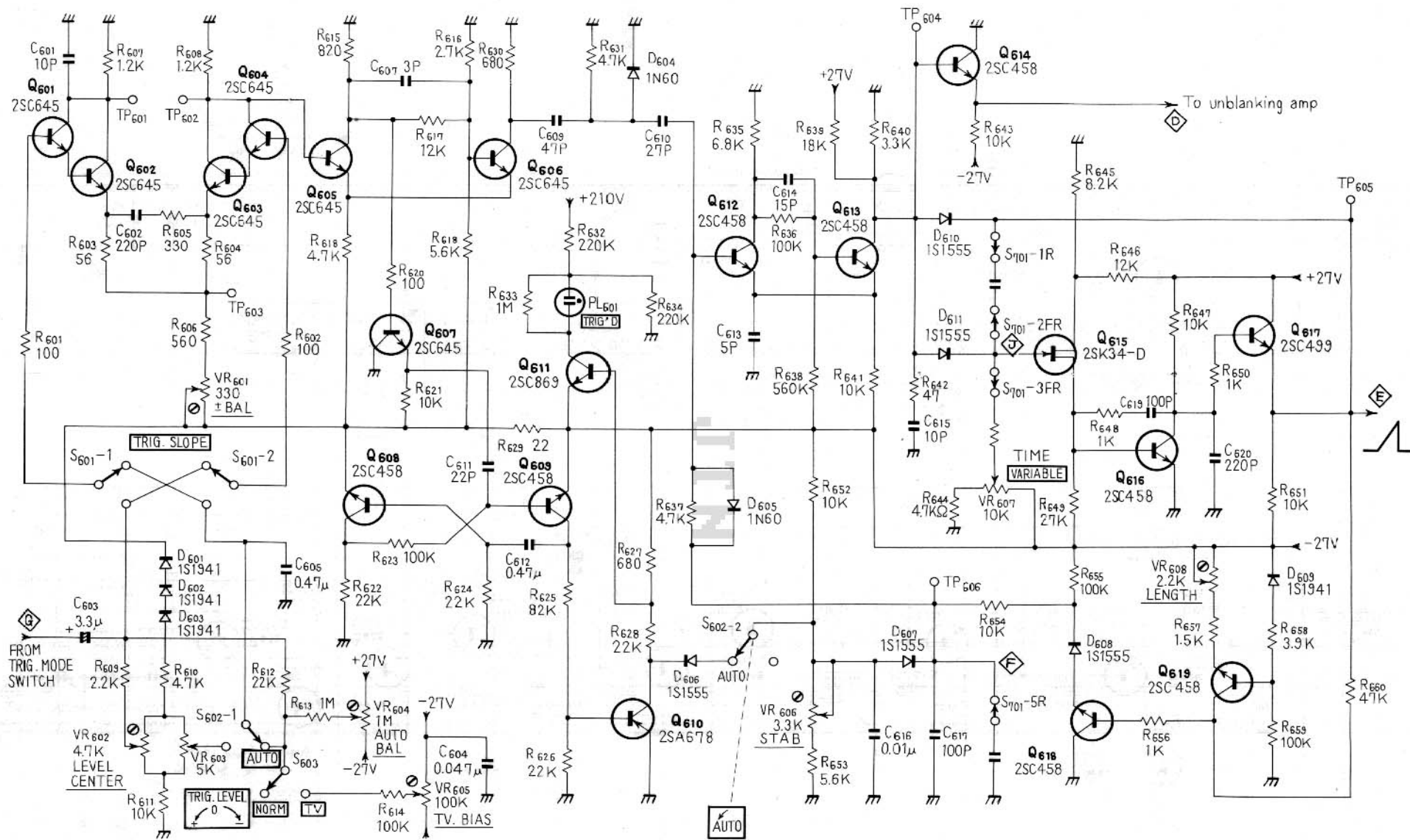

- R 601 ~ R 660
 VR 601 ~ VR 608
 C 601 ~ C 605, C 607, C 609 ~ C 617, C 619, C 620
 D 601 ~ D 611
 Q 601 ~ Q 619

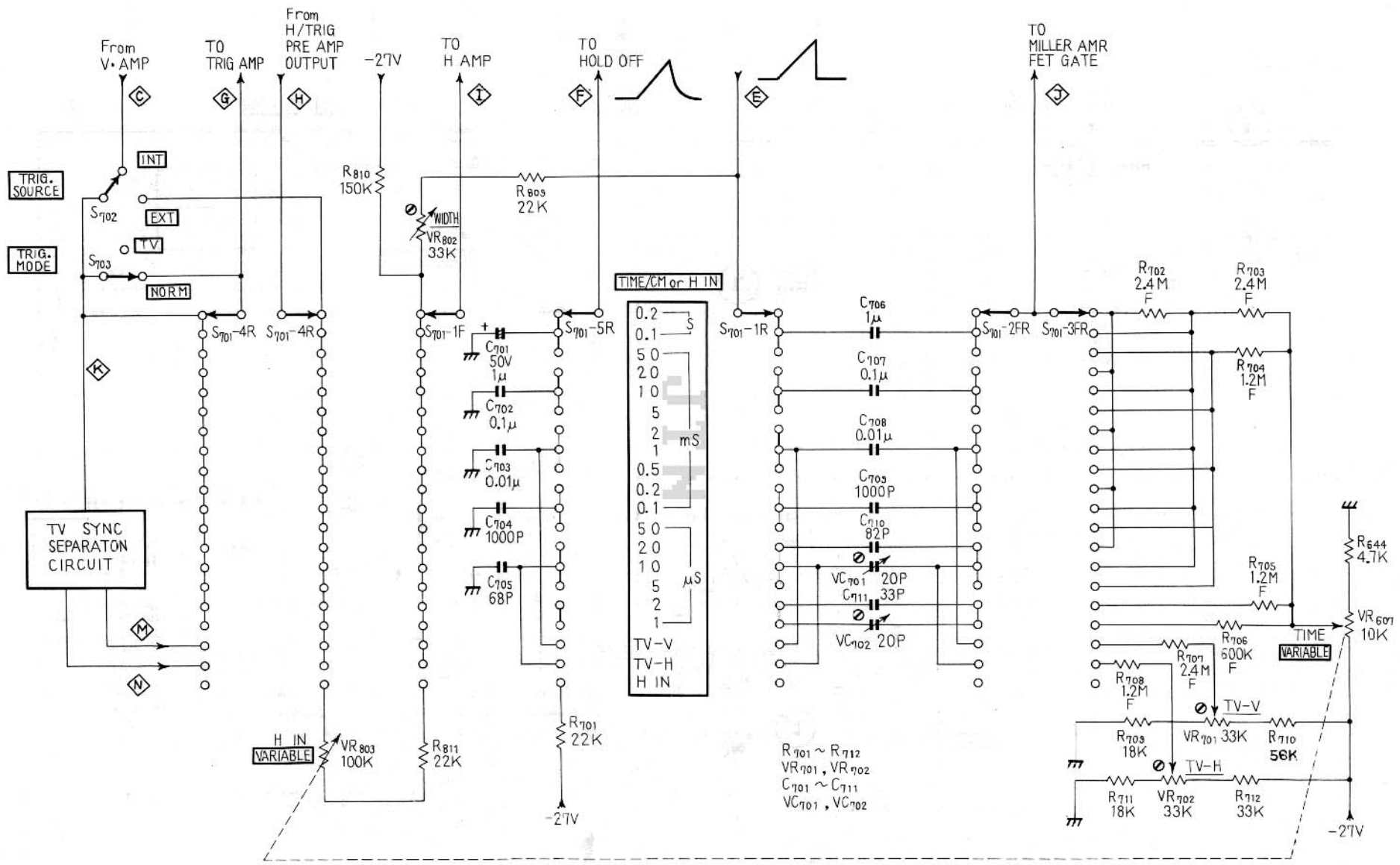

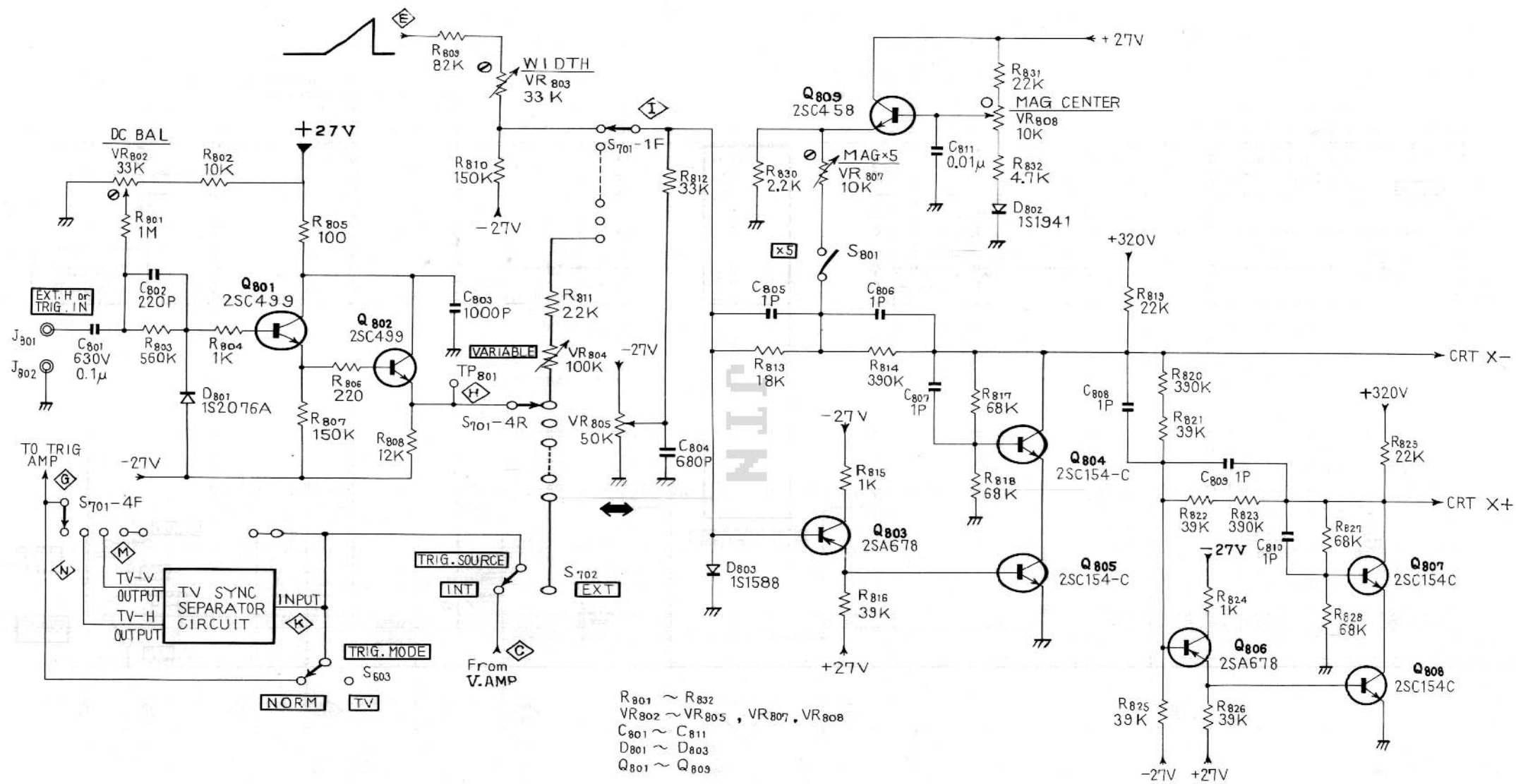

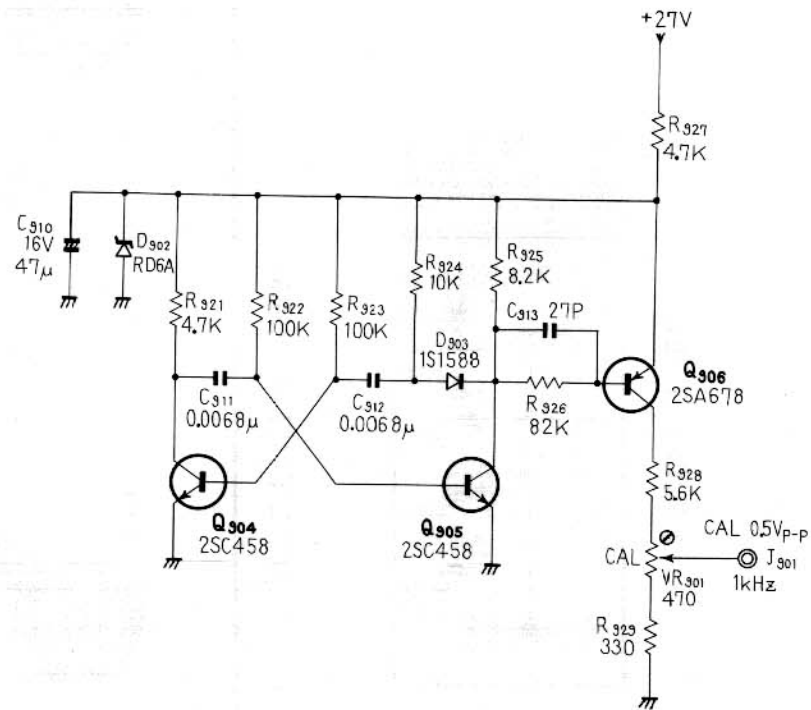
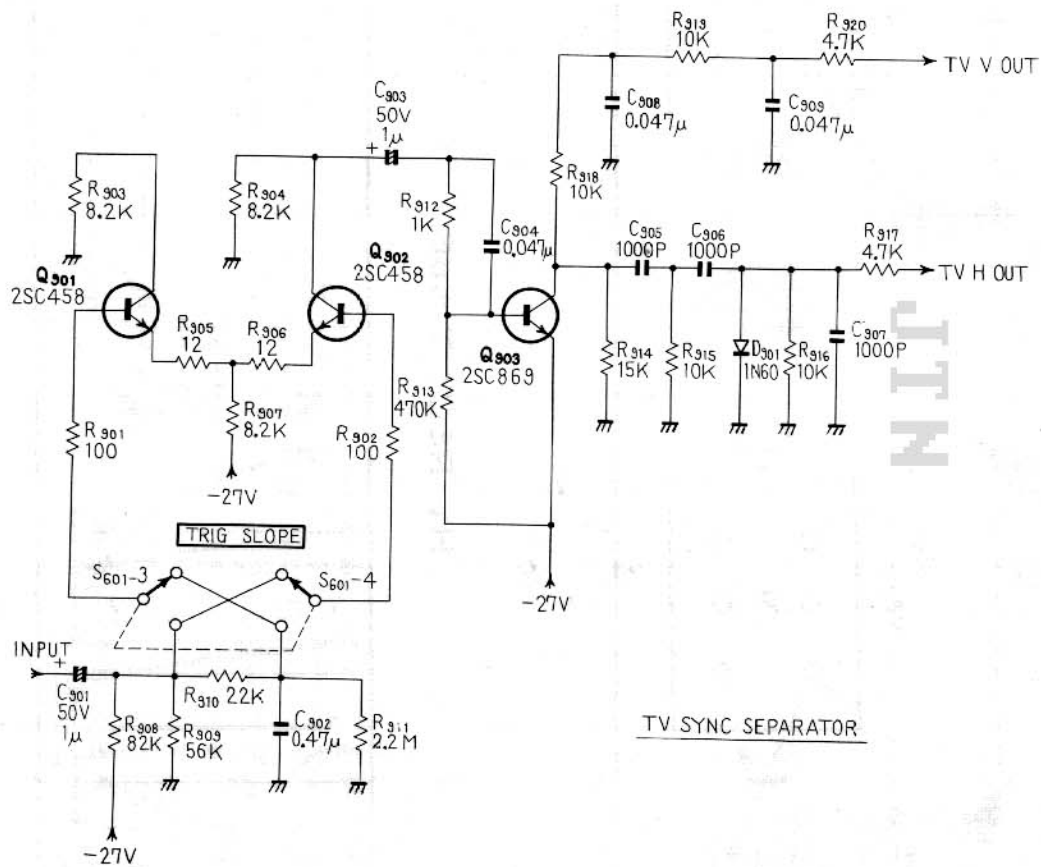

R₉₀₁ ~ R₉₂₉
 VR₉₀₁
 C₉₀₁ ~ C₉₁₃
 D₉₀₁ ~ D₉₀₃
 Q₉₀₁ ~ Q₉₀₆

PILOT T-665

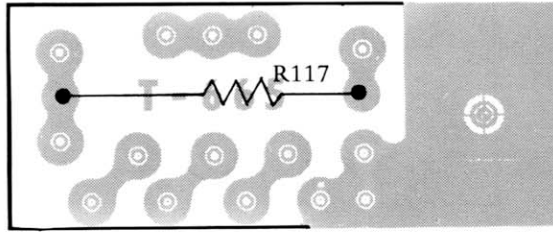

VECTOR T-294A

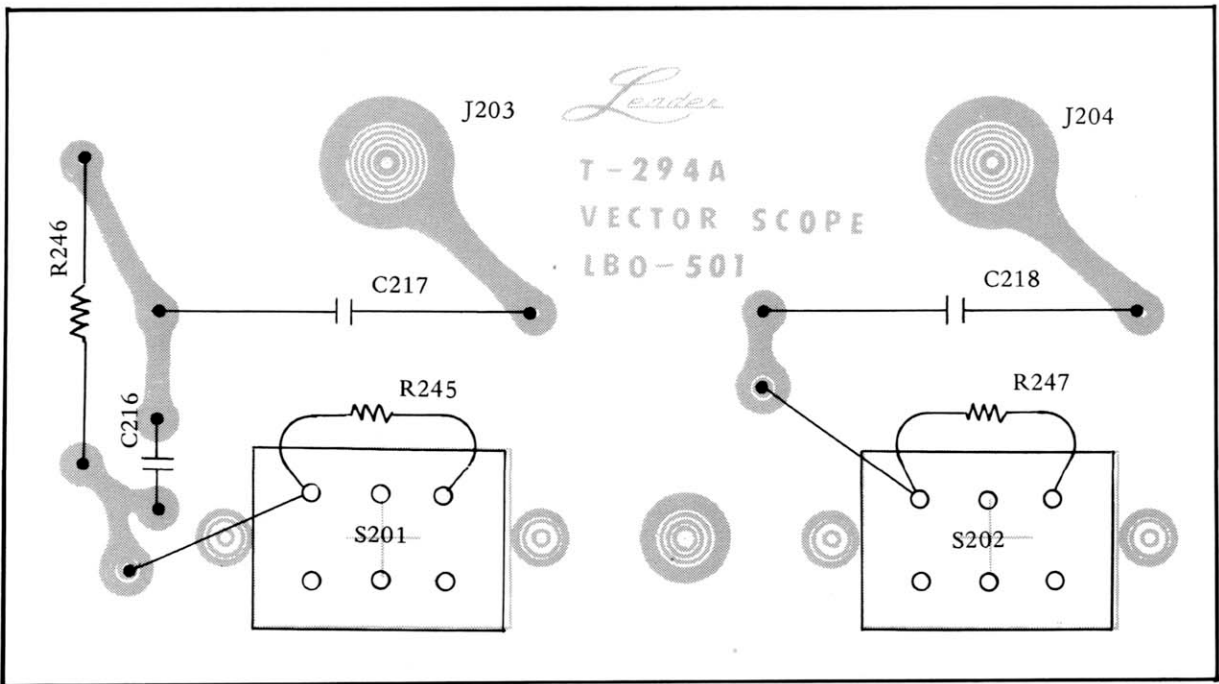

HV·RECT T-666

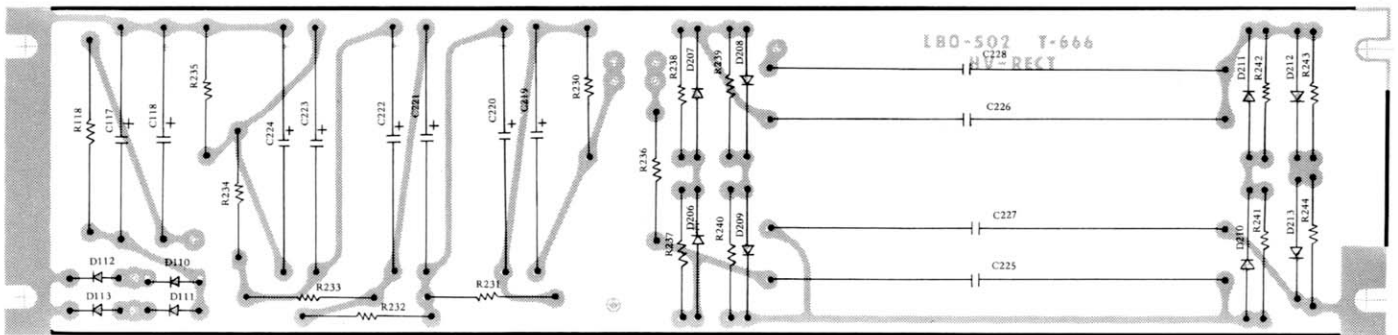

V · AMP T-664

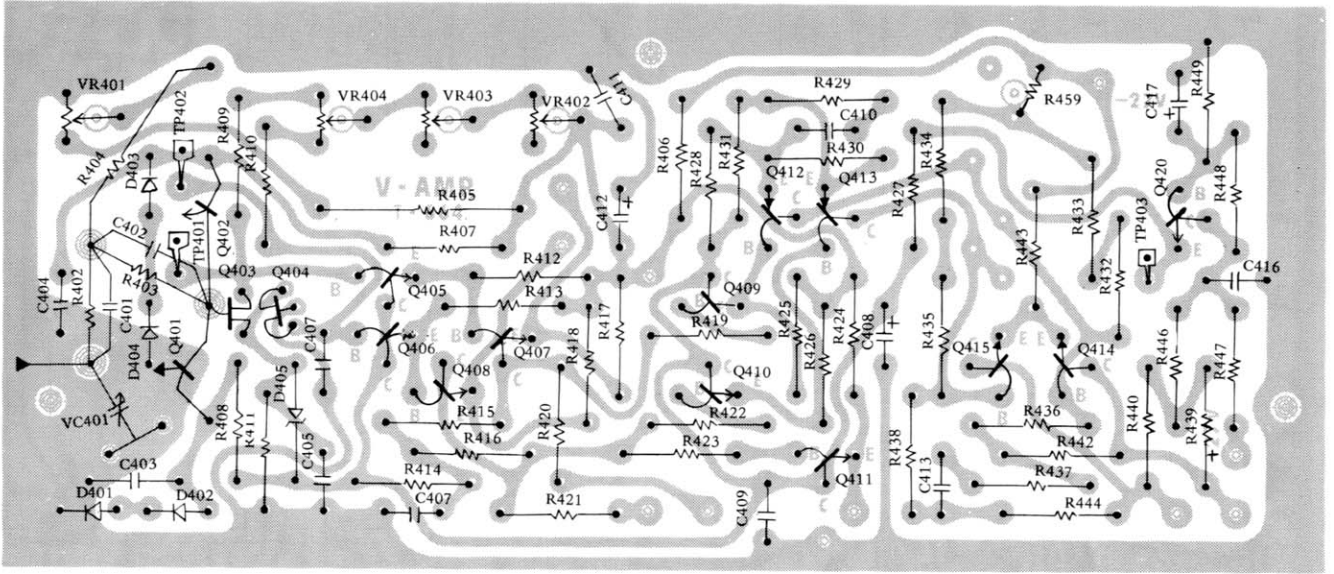

V · FINAL T-588A

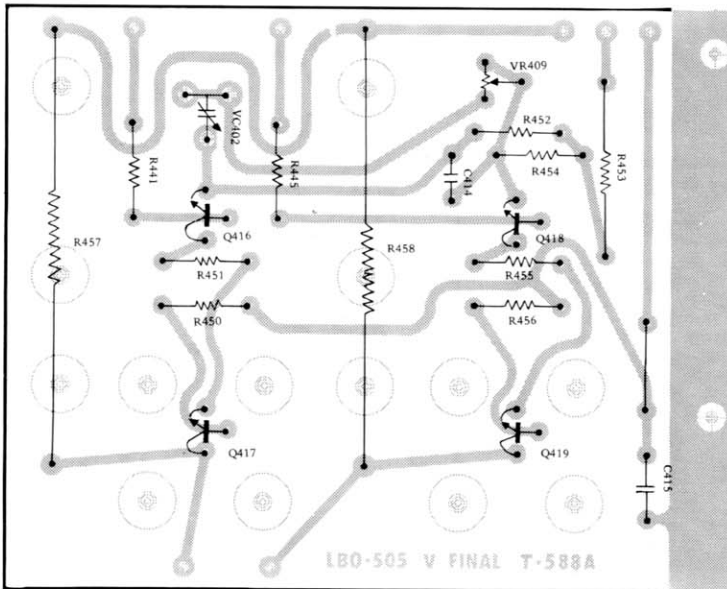

V · ATT T-663

